

У Вас сломался диодный лазер? Мы предлагаем ремонт и запчасти для многих диодных лазеров. Вы можете купить, заказать, приобрести запчасти и комплектующие для аппарата диодной лазерной эпиляции. Цена например диодной матрицы, ручки (манипулы, рукоятки) по контактным данным ниже. Чтобы узнать цену на запчасти диодного лазера от производителя – ждем фото аппарата и нужную деталь (проблему). Консультация по телефону +7(918)0110-234 . Доставка по России и СНГ от завода!!!

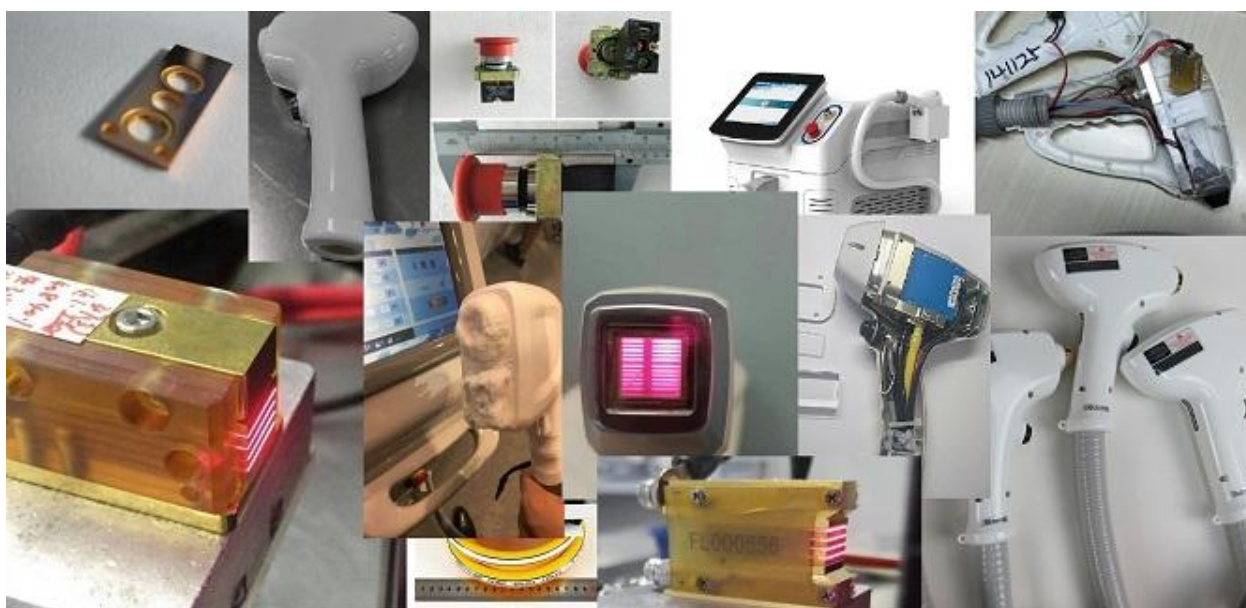

САЙТ - ROMSHI.COM.RU .

Email: Gnenik_roman@mail.ru .

Телефон - 8(918)0110-234 .

Купить, заказать диодные лазерные сборки, диодные матрицы, универсальные манипулы, ручки для диодных лазеров для эпиляции. Продажа запчастей и комплектующих для лазеров в России и СНГ.

Продажа матрицы для диодного лазера любого типа. Вы можете заказать диодные сборки (выбор по мощности,барам)и другие запчасти и комплектующие для ремонта и восстановления работоспособности диодного лазера . Универсальные манипулы на диодный лазер. Ремонт лазеров и оборудования для диодной эпиляции.

Мы **предлагаем** под заказ **диодные лазерные сборки** , универсальные манипулы для аппаратов диодной эпиляции. Мы можем поставить с доставкой комплектующие и запасные части для любых диодных и гибридных лазеров, диодных лазеров с вакуумным усилением и аппаратов для эпиляции: Kiers 144, Kiers 145, D-las, FG-2000B, DPSS, SHR BL1, Wingderm, SL 600, SL 500, DL-07, FG2000D, SDL-C, Ruikd, LD4, Silvano, Esteban+ и других марок.

ДОСТАВКА ПО РОССИИ И СТРАНАМ СНГ. Различные виды оплаты.

Product display

Good effect- Permanent and painfree hair removal after two times treatment



ПРОДАЖА диодных лазеров в следующем разделе сайта .

ДЛЯ ЗАКАЗА и консультации по **диодным сборкам** электронная почта Gnenik_roman@mail.ru **телефон** (ватсапп,телеграмм) +7 (918) 0110-234(Роман).

Ниже ознакомительная информация по устройству диодных манипул, видам диодных сборок, проблемам диодных лазеров. Множество фотографий с ремонта и новым запчастям и комплектующим для диодного лазера. Если Вас интересует какой то вопрос, то Вы можете проконсультироваться.

Диодные лазерные сборки и матрицы для Alma Lasers

Запчасти Harmony XL
Запчасти Soprano Ice Platinum
Запчасти Pixel CO2
Запчасти Soprano XL
Запчасти Pixel CO₂ FemLift
Запчасти Alma Arion
Запчасти Accent XL (Prime)
Запчасти Soprano Accord
Запчасти Burane II
Запчасти Idas
Запчасти Sinon II
Запчасти Alma-Q

На фотографии ниже диодная сборка (диодная матрица) внутри манипулы диодного лазера.

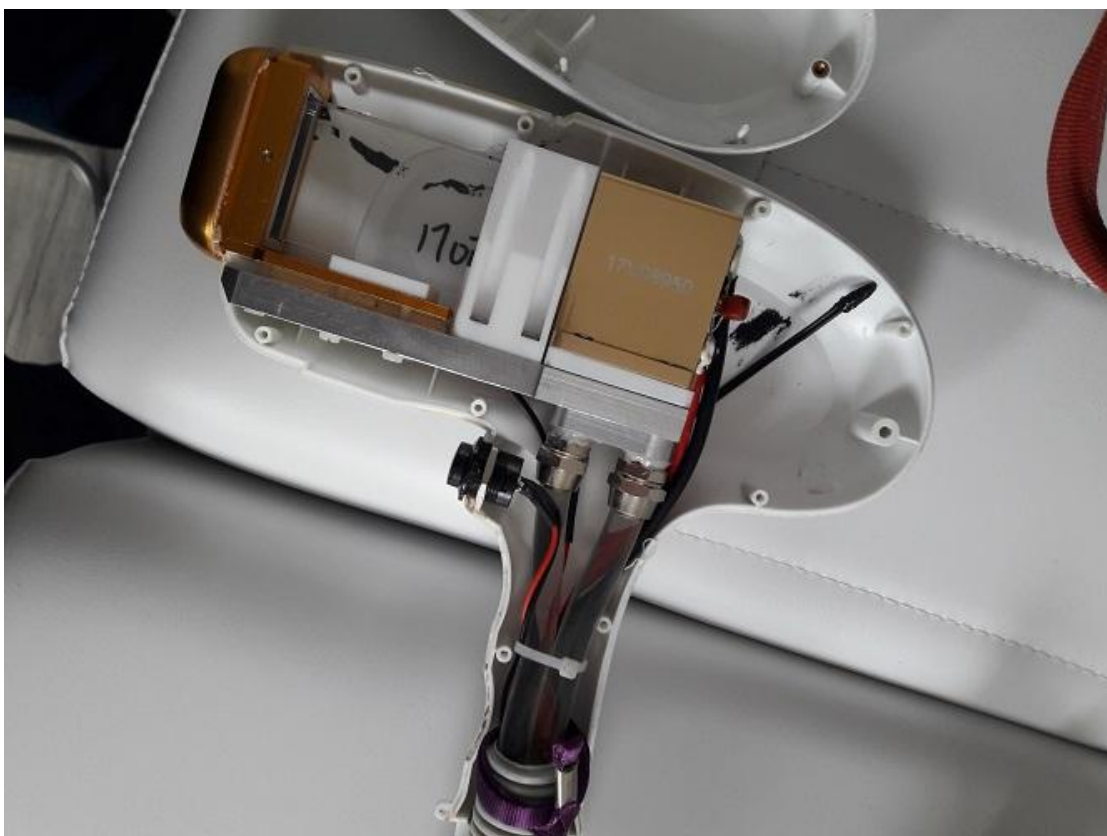

Диодные матрица различаются по видам.

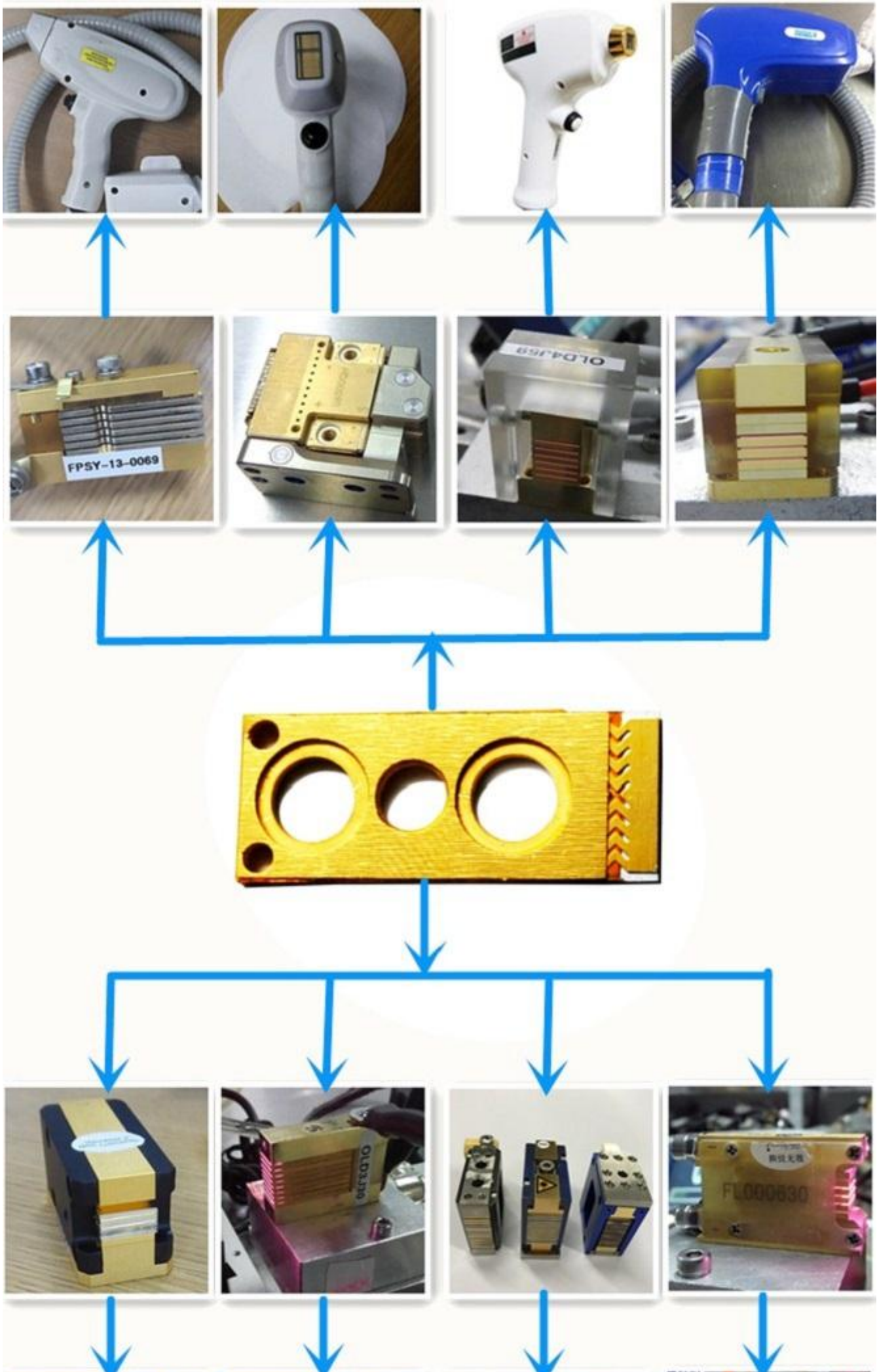

Диодная матрица состоит из диодных стэков. **Сборки лазерных** диодов (также называемые массивом **лазерных** излучателей, стеками или матрицами) состоят из определённого числа **диодных лазерных** сборок или баров, которые образуют единый излучающий массив. Наиболее распространённым расположением баров является вертикальное расположение,

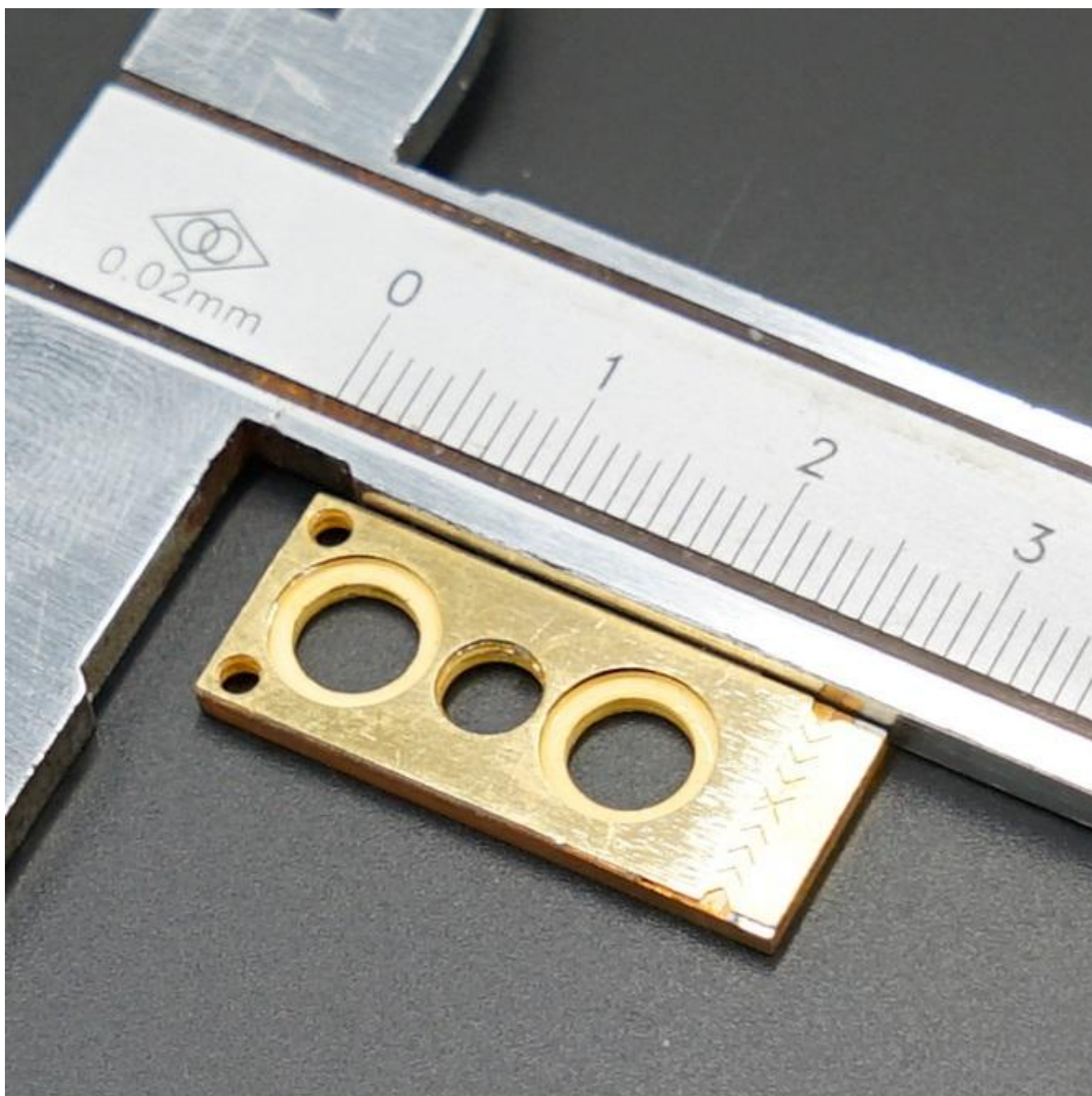

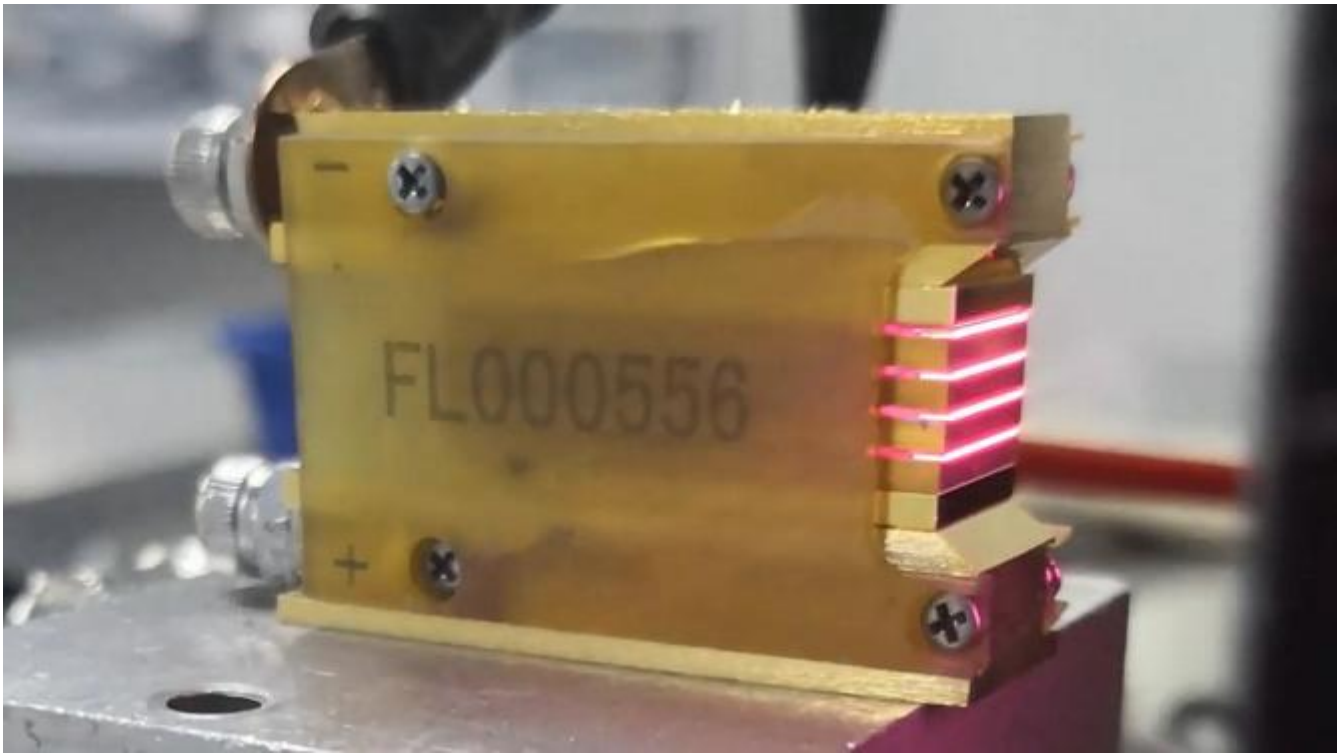

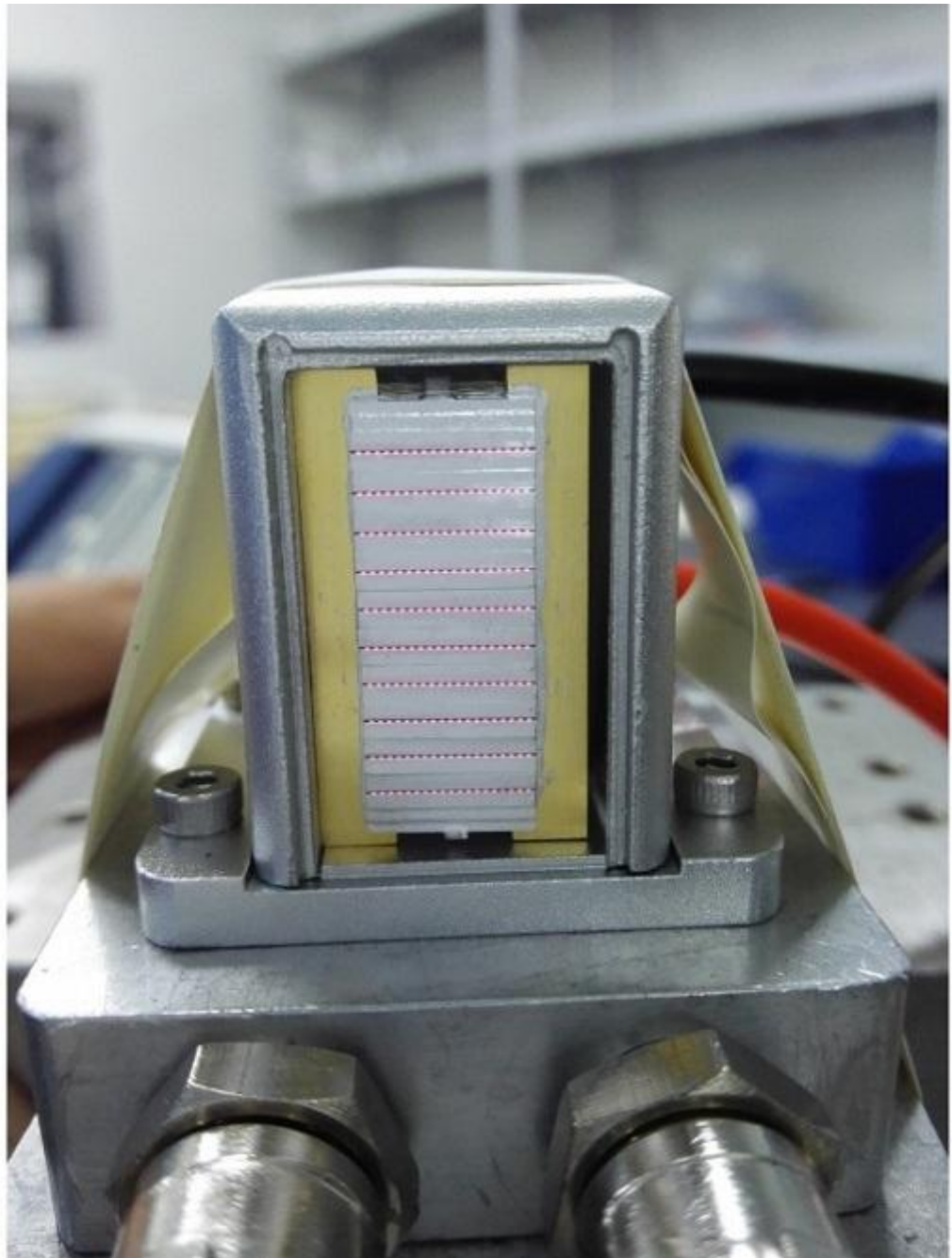

AlmaSoprano-B

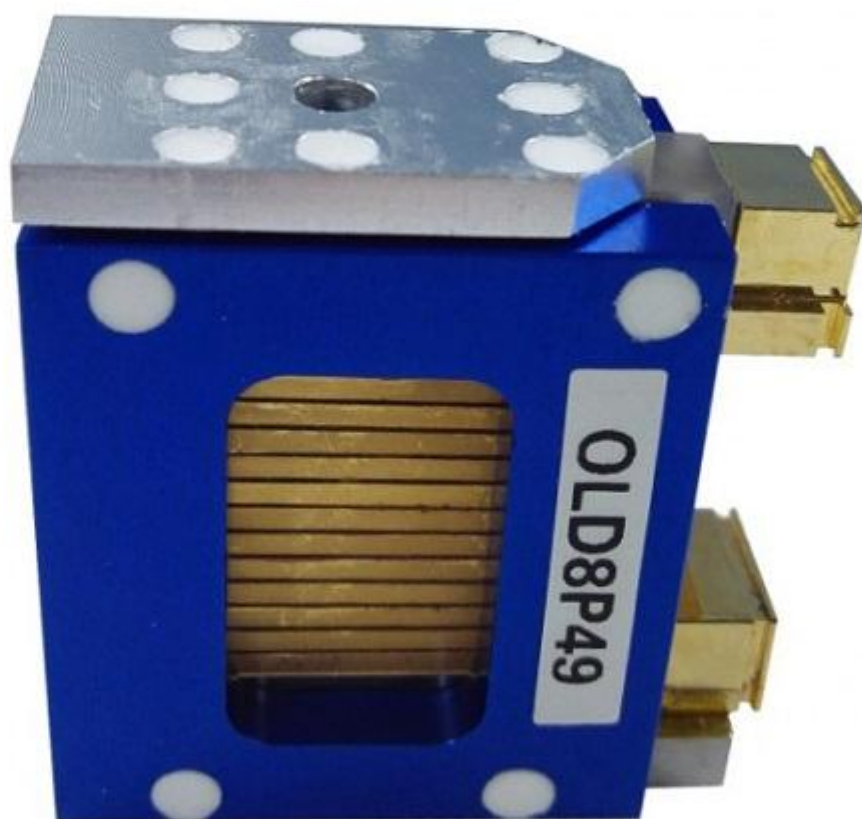

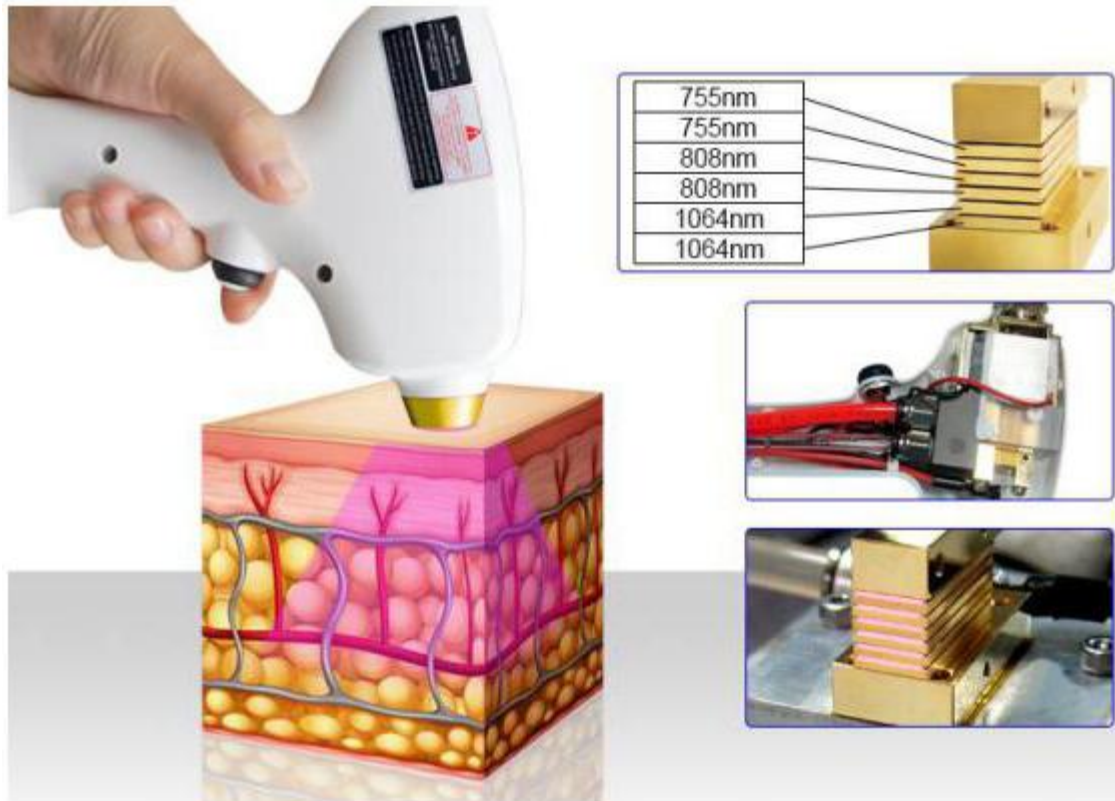

Диодные лазерные сборки для любых диодных и гибридных лазеров, диодных лазеров с вакуумным усилением и аппаратов для эпиляции:
Kiers 144, Kiers 145, D-las, FG-2000B, DPSS, SHR BL1, Wingderm, SL 600, SL 500, DL-07, FG2000D, SDL-C, Ruikd, LD4, Silvano, Esteban+ и других марок







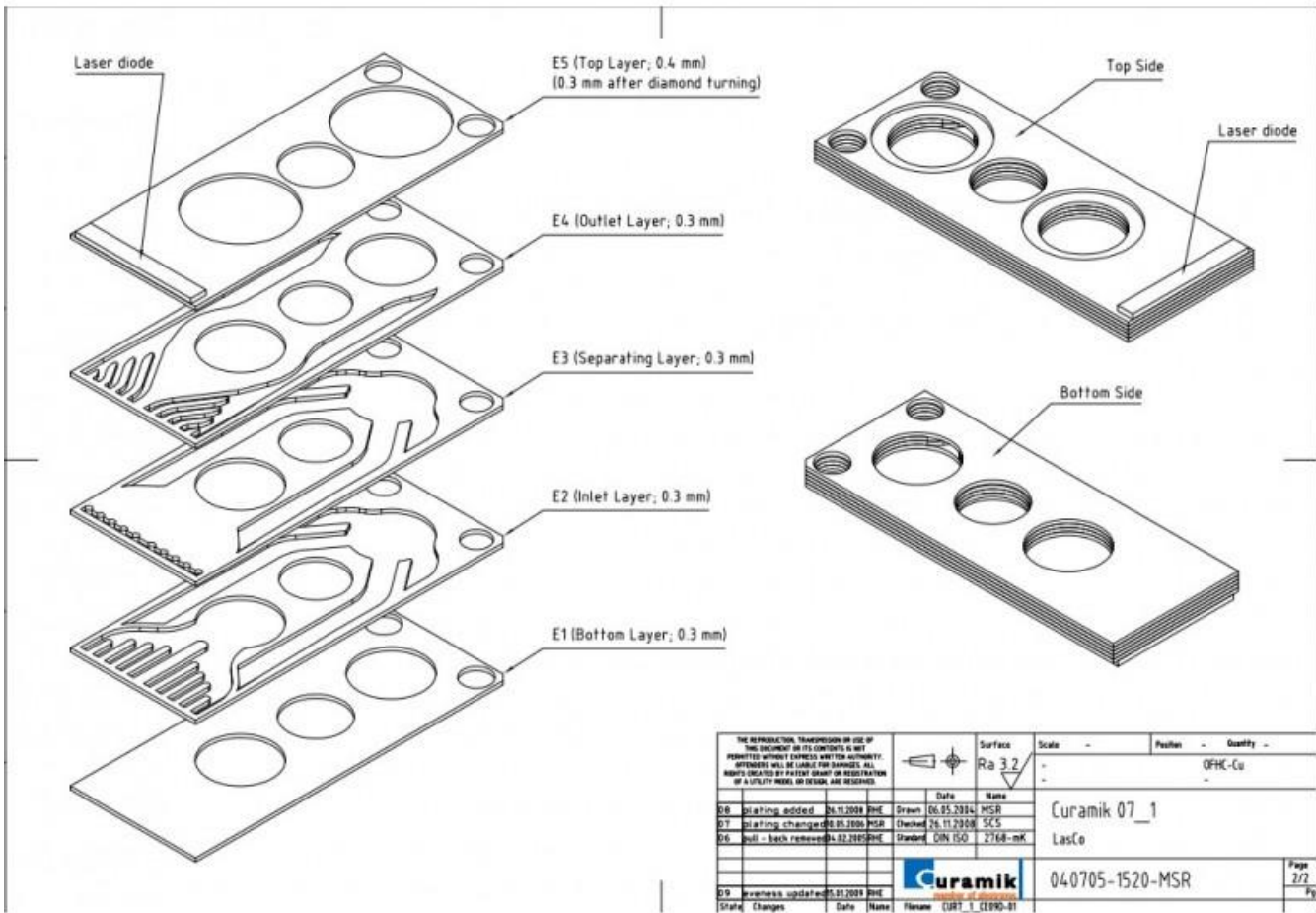

<small>THE REPRODUCTION, TRANSMISSION OR USE OF THIS DOCUMENT OR ITS CONTENTS IS NOT PERMITTED WITHOUT EXPRESS WRITTEN AUTHORITY. OFFENDERS WILL BE LIABLE FOR DAMAGES. ALL RIGHTS RESERVED BY PATENT, TRADE OR REGISTRATION OF A UTILITY MODEL OR DESIGN ARE RESERVED.</small>				Surface Ra 3.2	Scale - - -	Position - - -	Quantity - - -
			Date	Name	Curamik 07_1		
D.B. plating added 01.11.2008 RHE			Drawn	06.05.2004 MSR	LasCo		
D.T. plating changed 01.11.2008 MSR			Checked	26.11.2008 SCS			
D.G. hull - back removed 02.2008 RHE			Standard	DIN ISO 2768-mK			
					040705-1520-MSR		
D.D. process updated 05.01.2008 RHE			<small>Member of alpi group</small>		Page 2/2		
State changes			Date	Name	File: CURT_1_C1940-01		

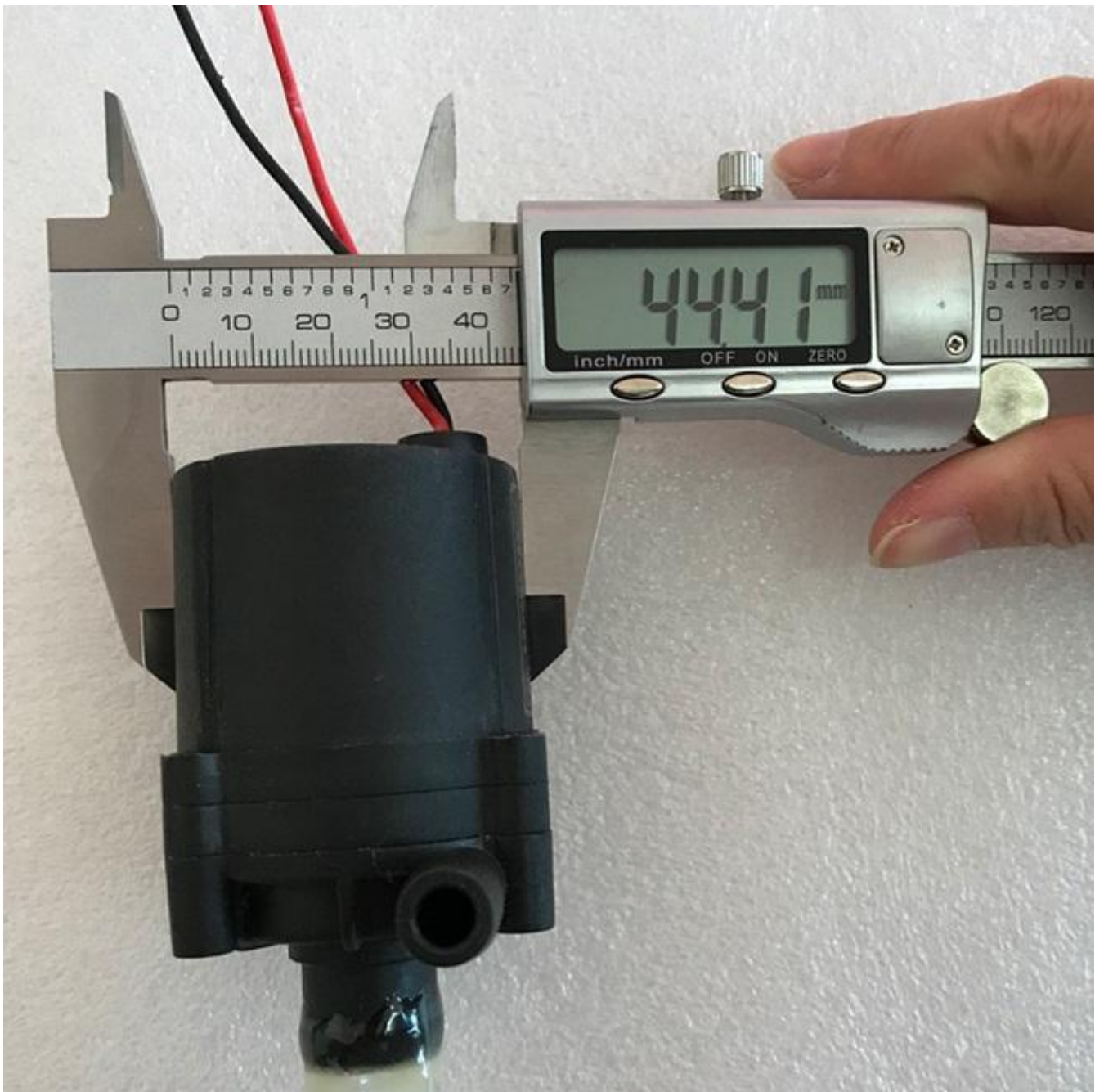

Для работы диодных лазеров требуется дистиллированная вода. Ее можно купить в автомагазине. Если использовать другую воду (обычную), то от вспышек будет налет на ксеноновой лампе и на кристалле. Отсюда качество вспышки хуже

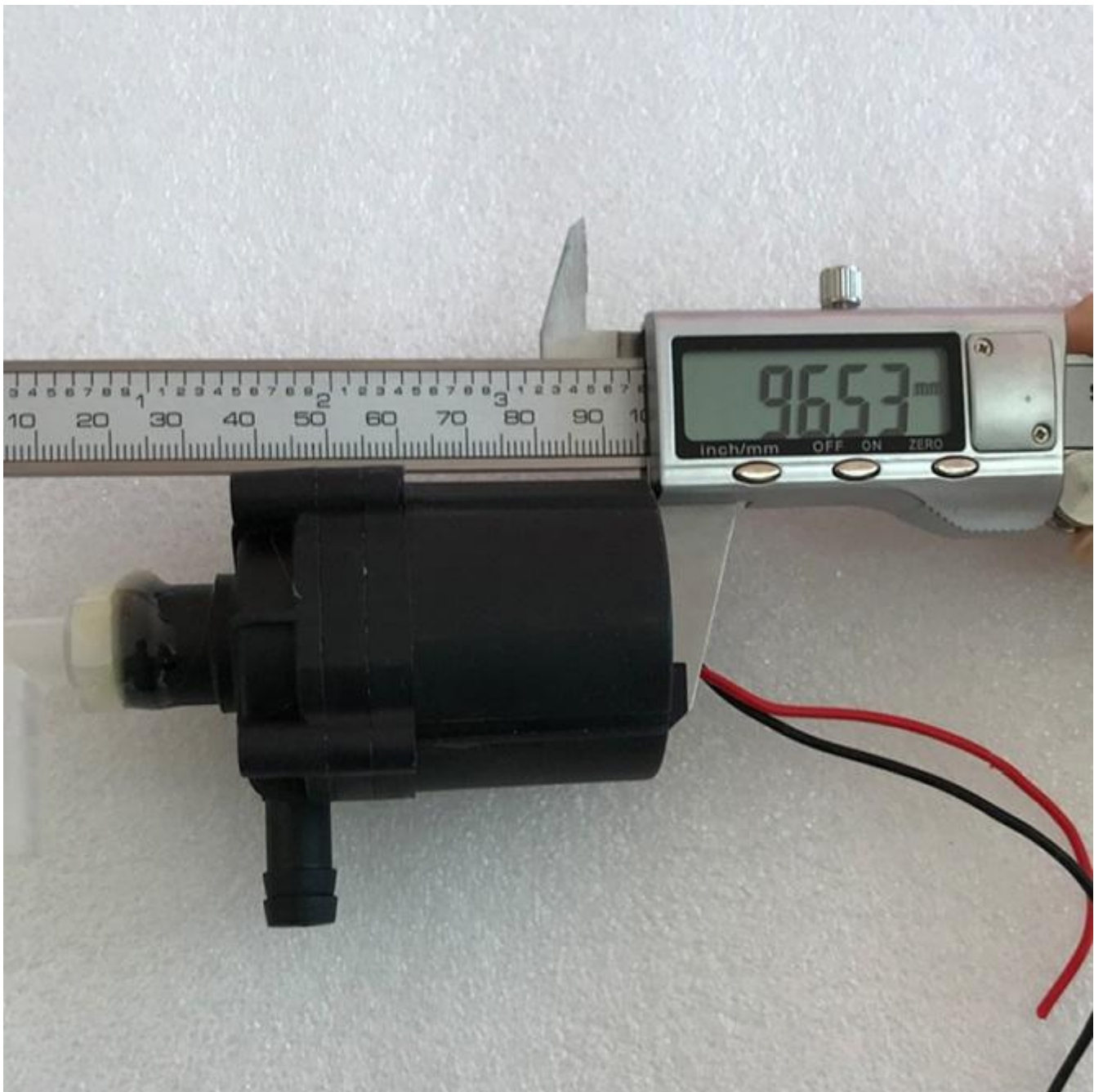









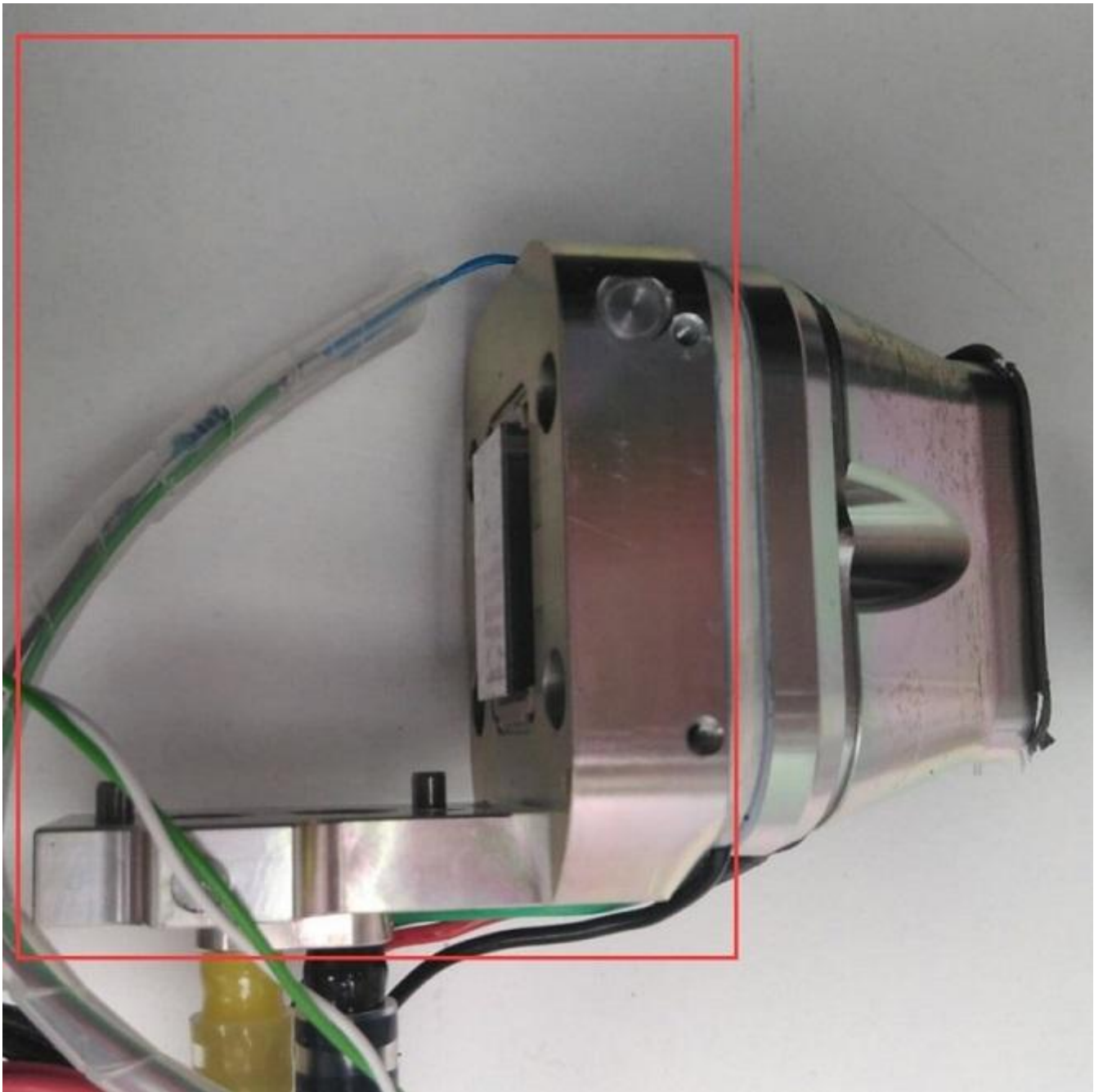

Диодные лазерные сборки для любых диодных и гибридных лазеров, диодных лазеров с вакуумным усилением и аппаратов для эпиляции: Kiers 144, Kiers 145, D-las, FG-2000B, DPSS, SHR BL1, Wingderm, SL 600, SL 500, DL-07, FG2000D, SDL-C, Ruikd, LD4, Silvano, Esteban+ и других марок.



SE-600-15



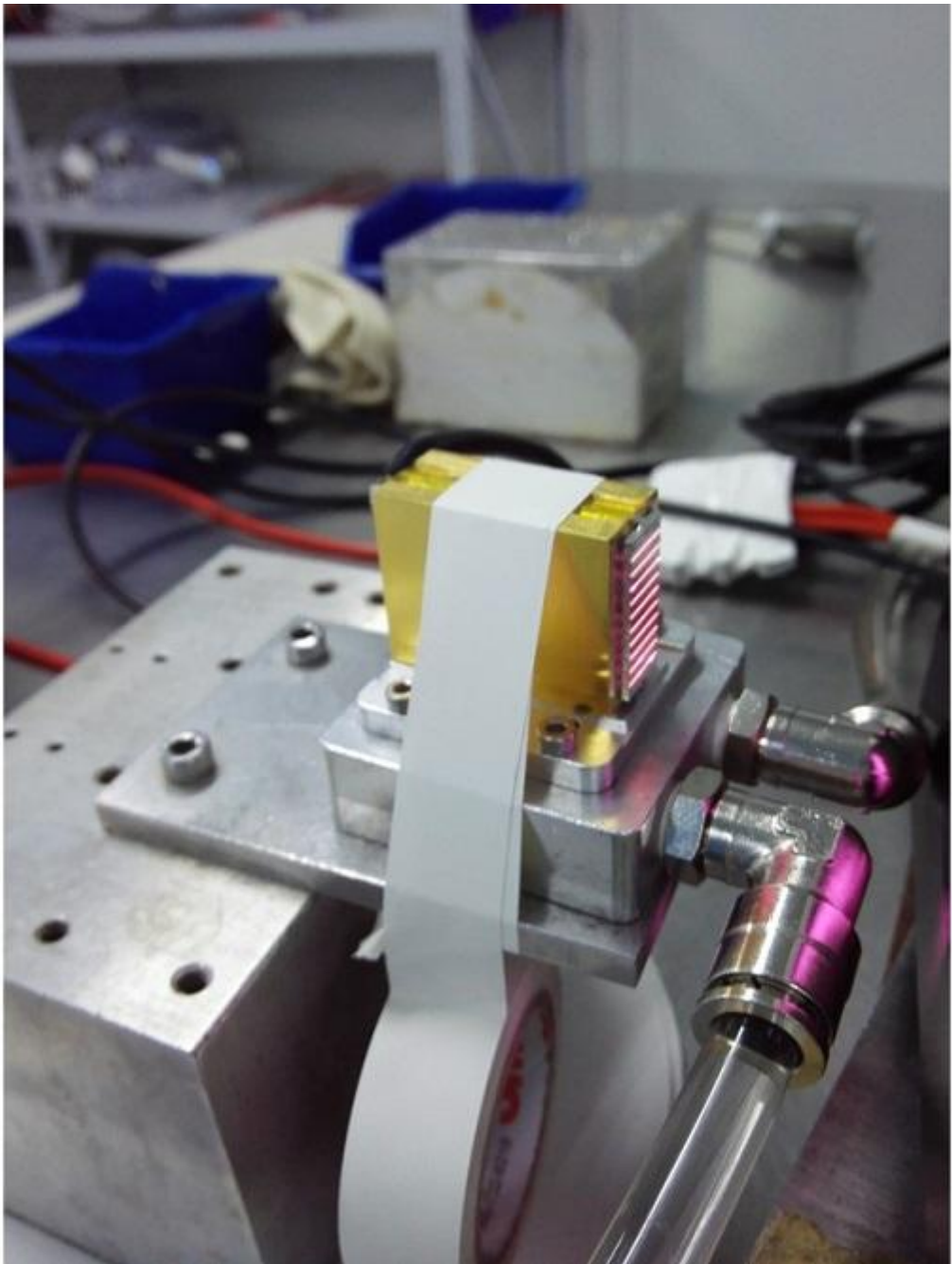

AlmaSoprano-C

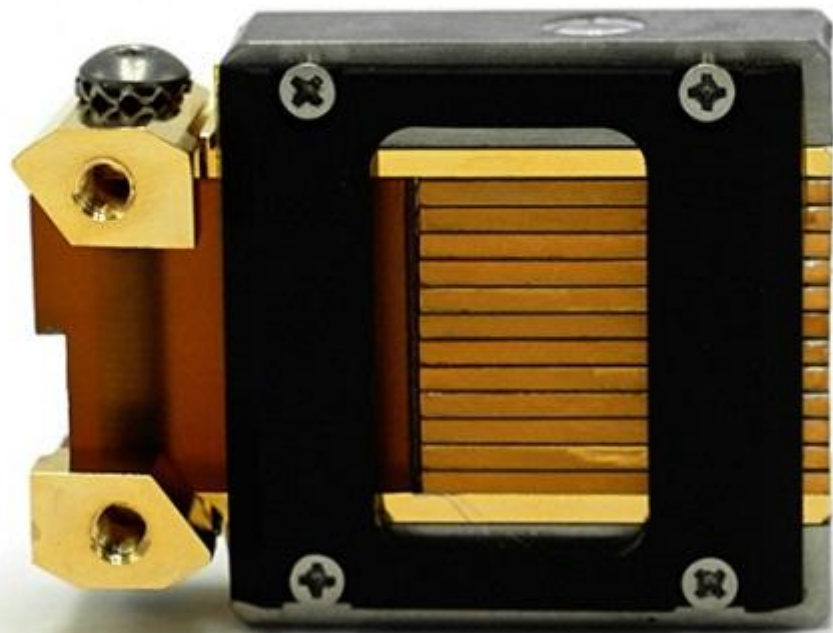

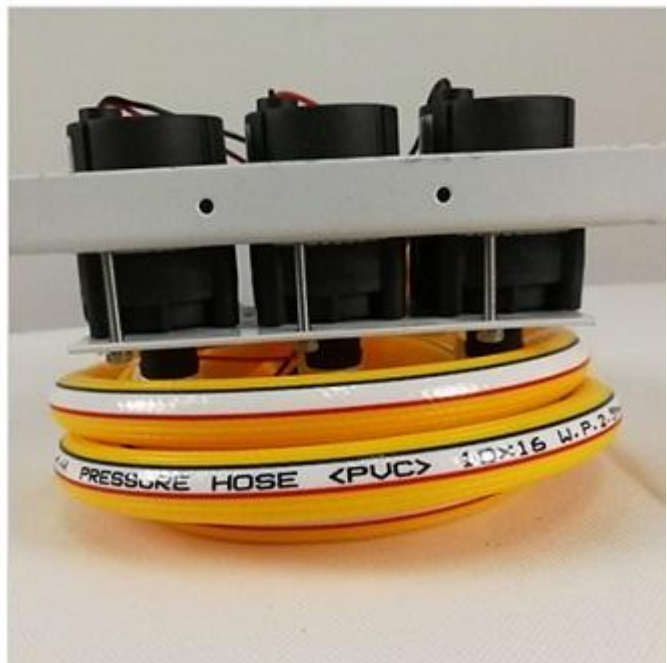
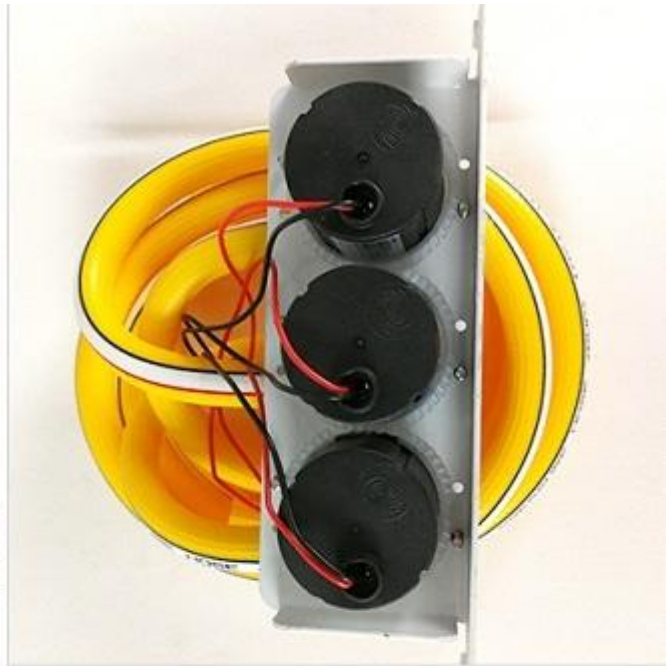
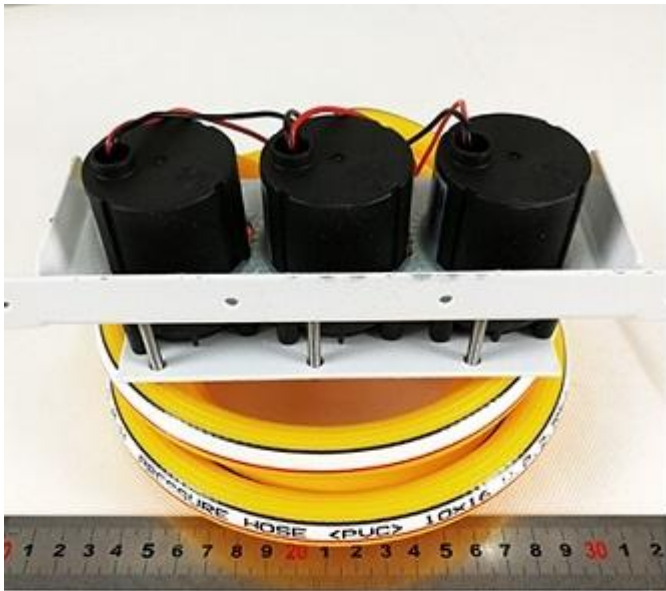



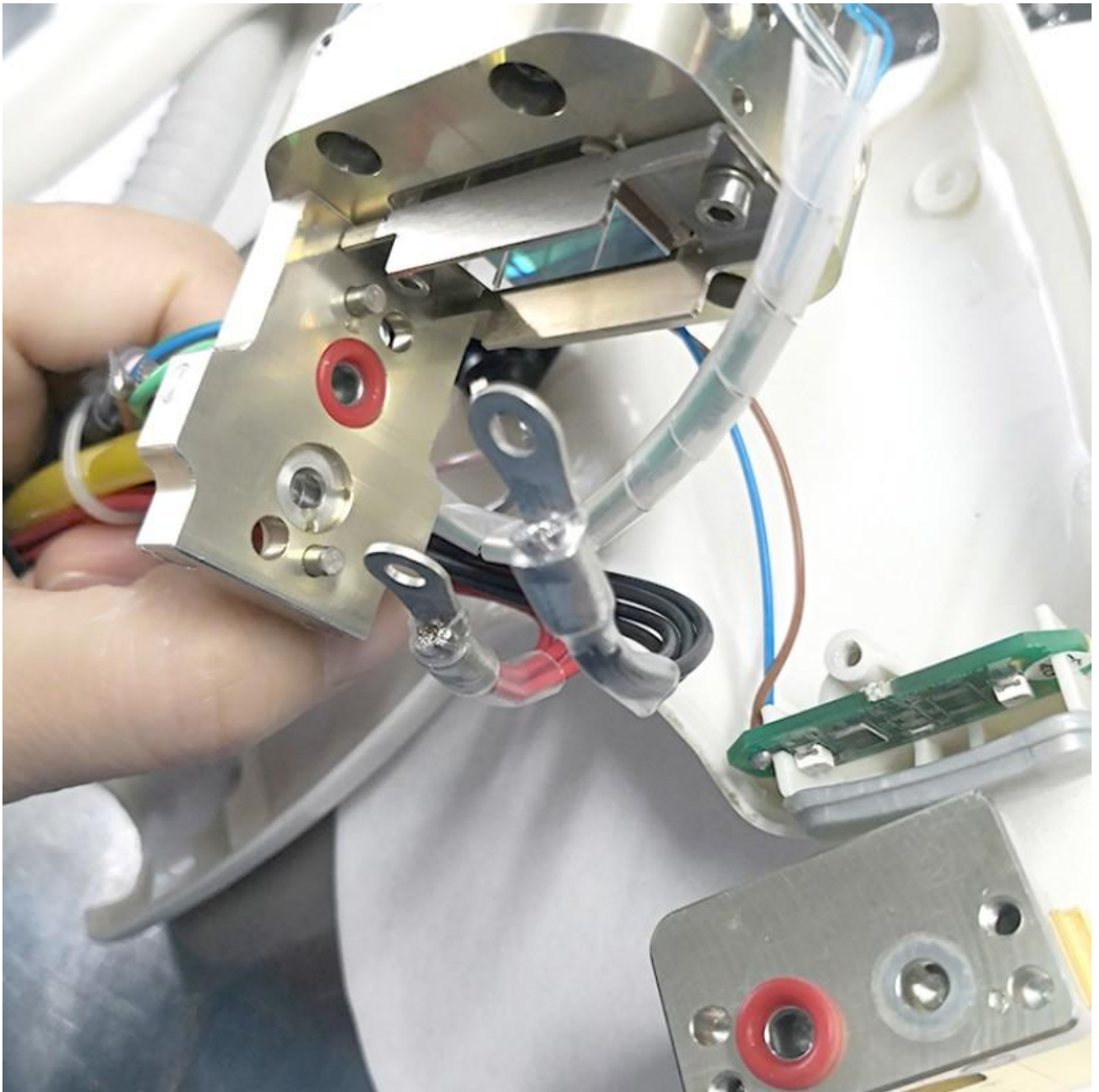



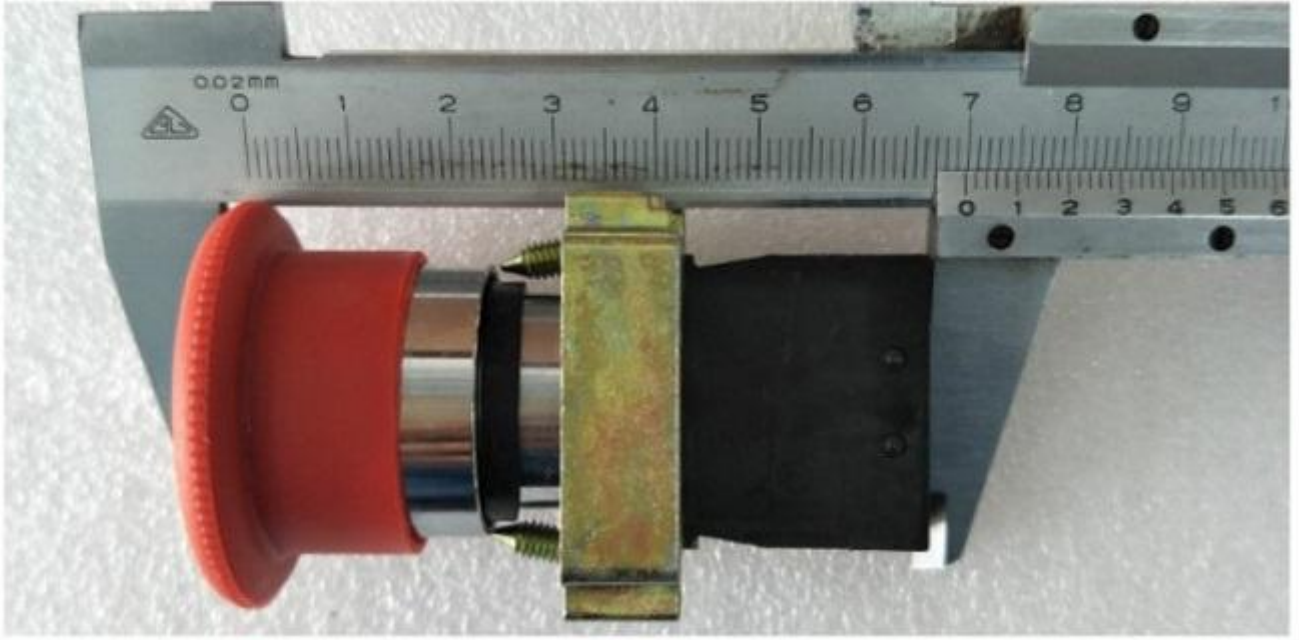
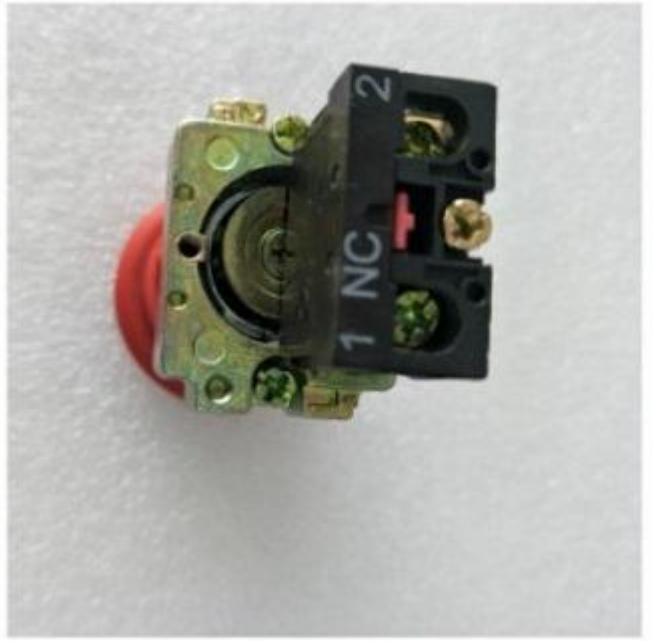

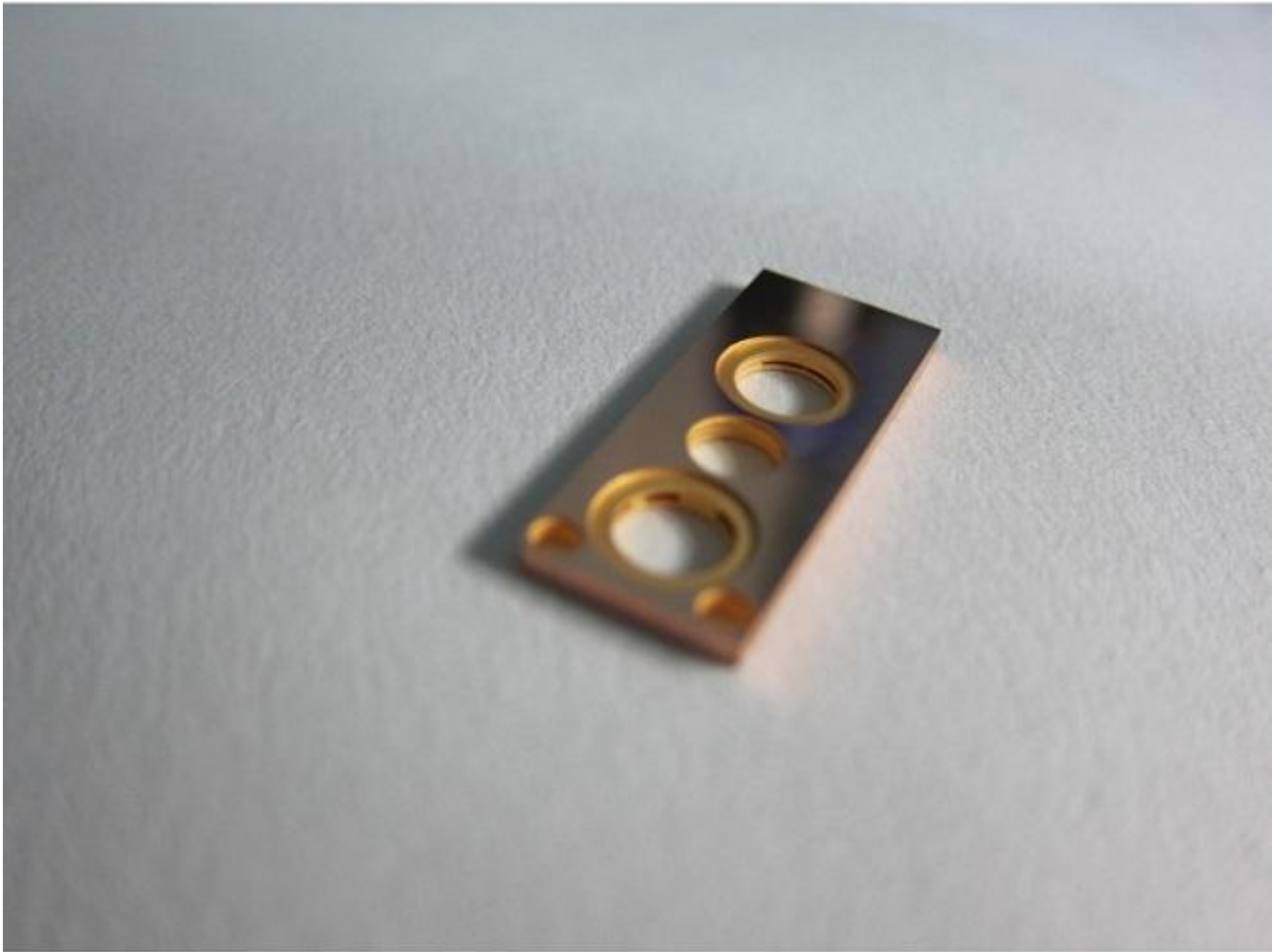

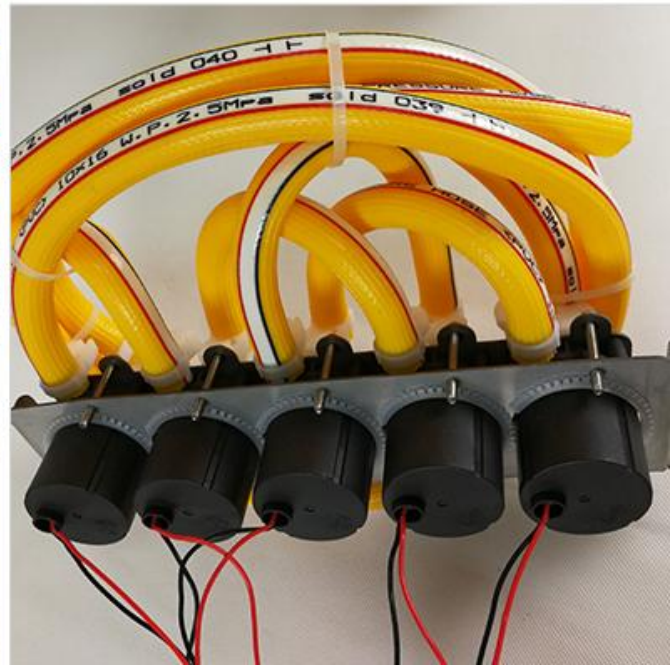
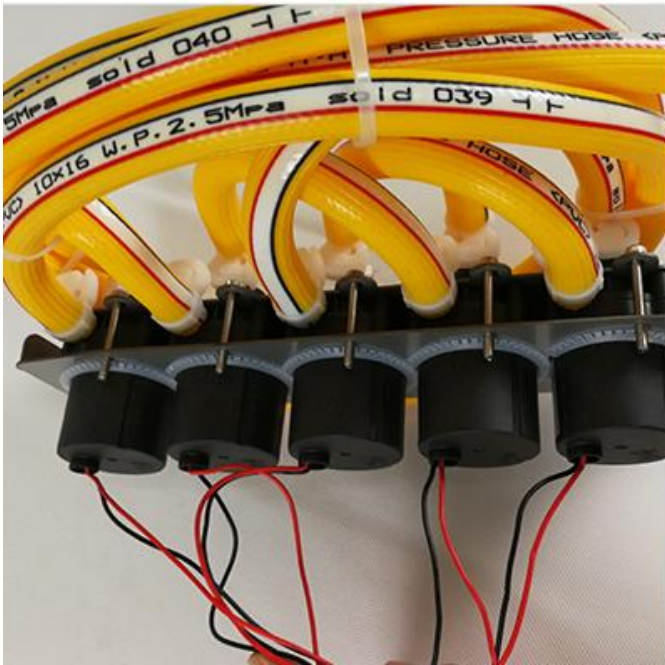
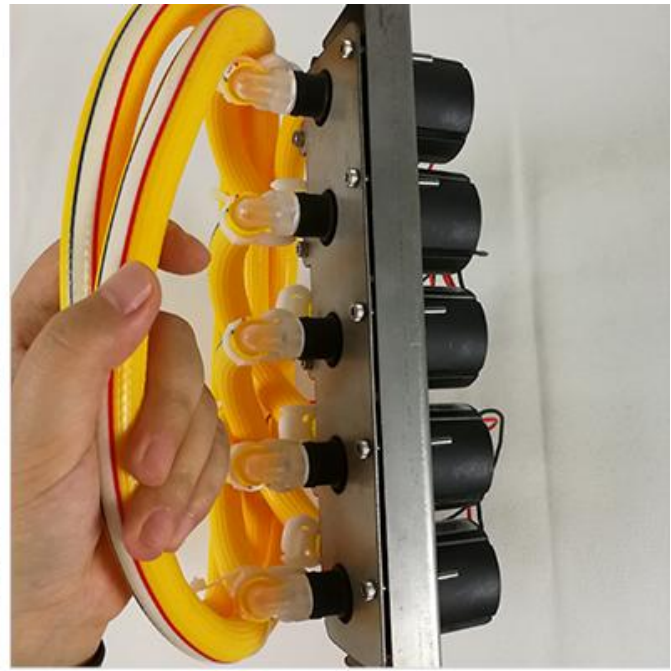
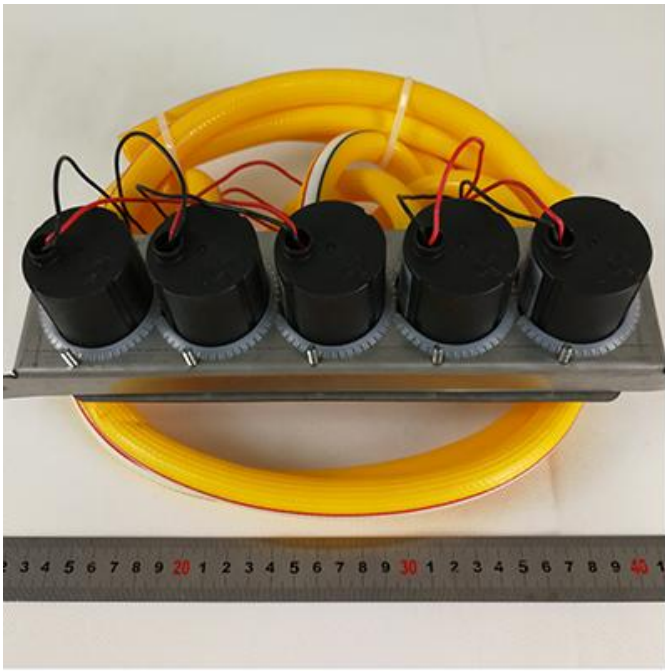





808nm laser

755nm laser

1064nm laser

808nm laser





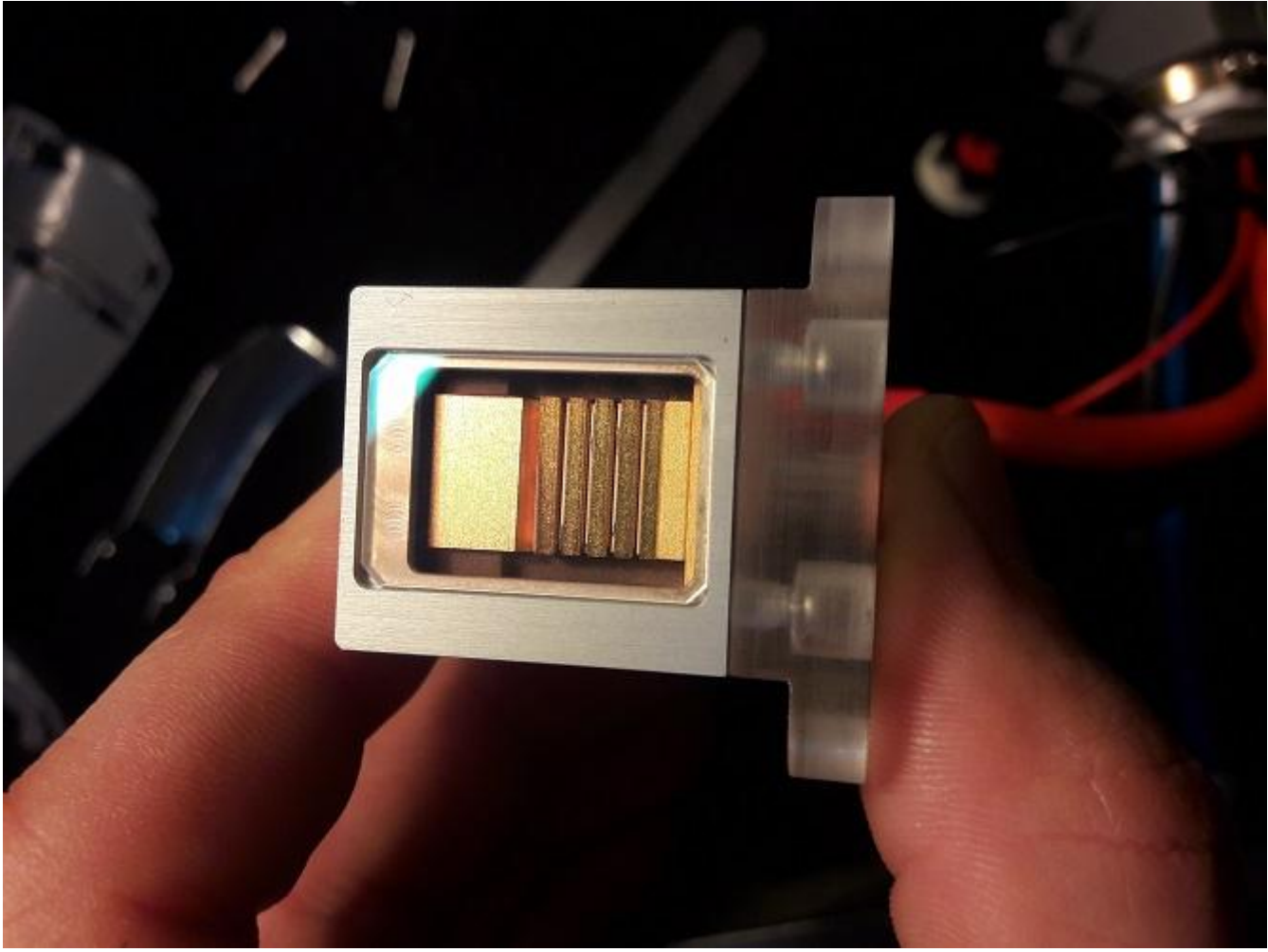



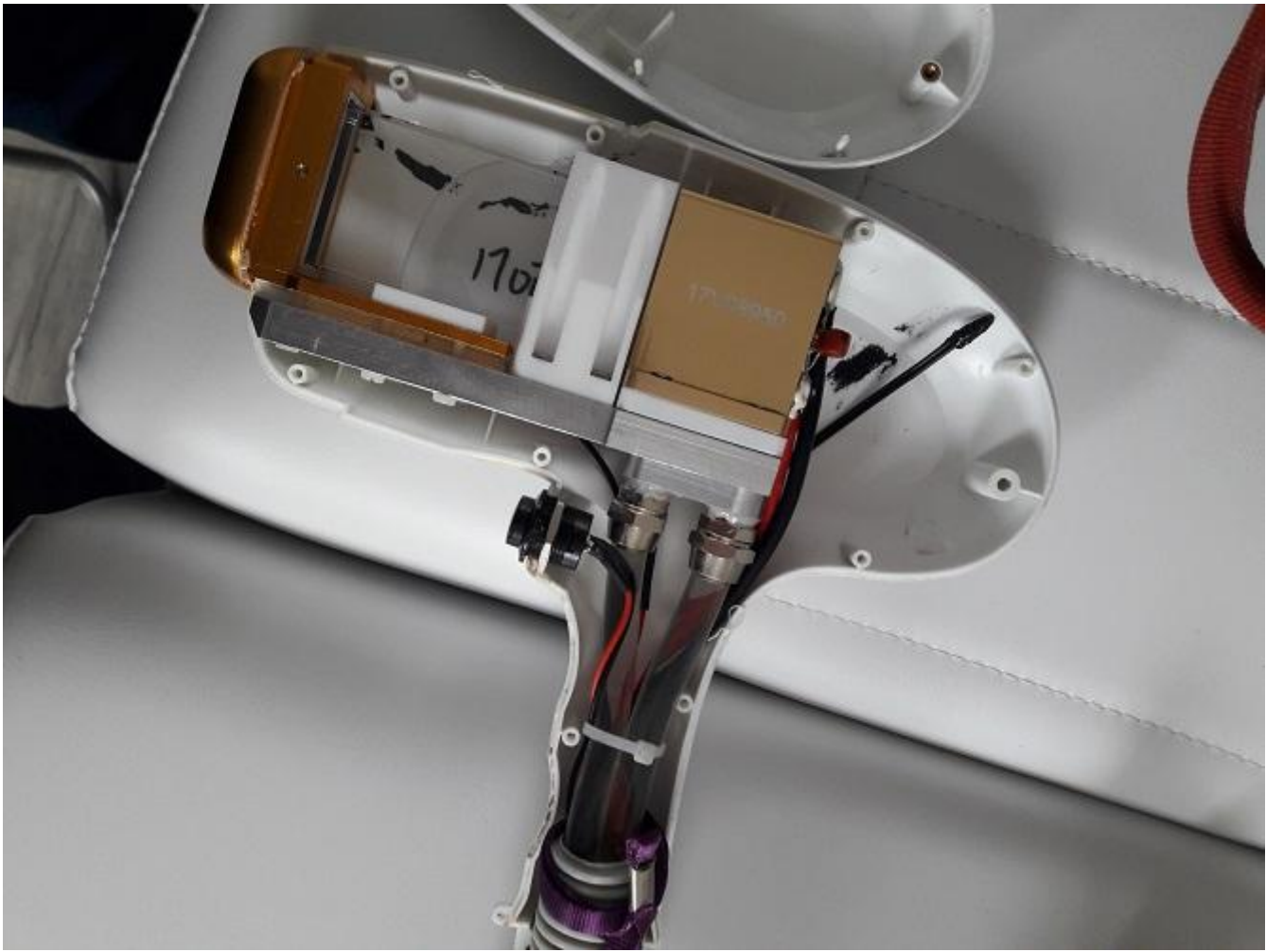



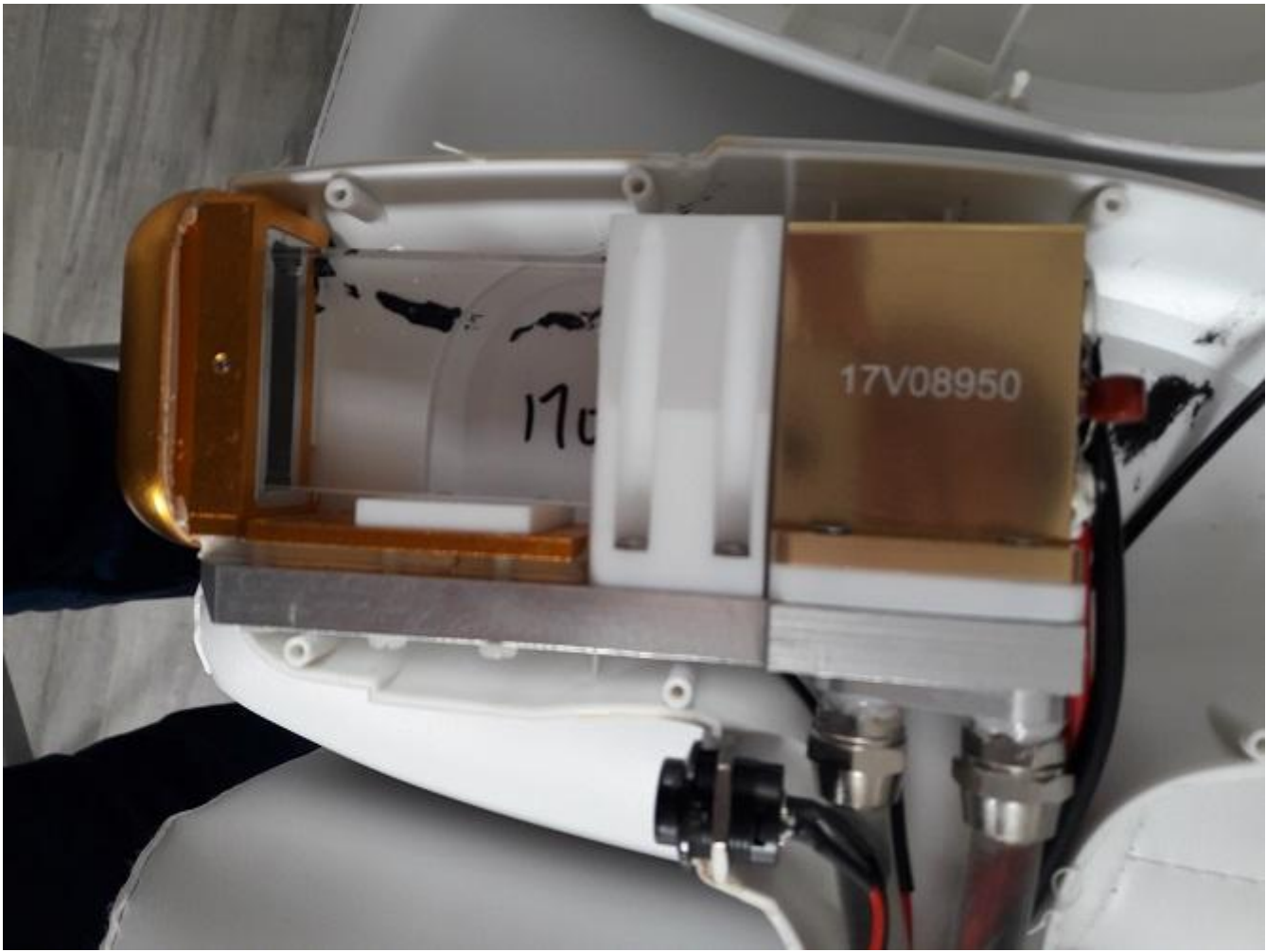



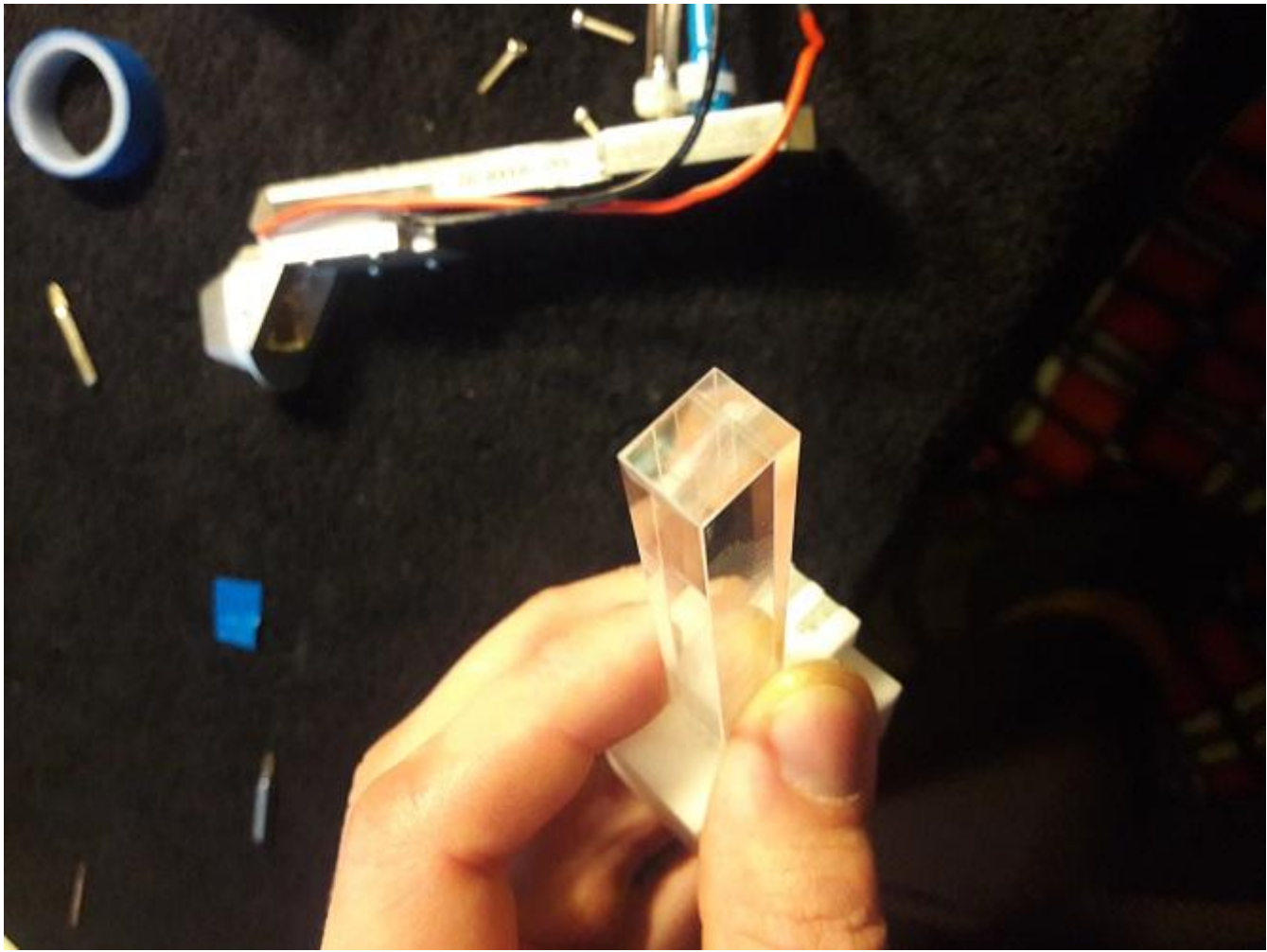







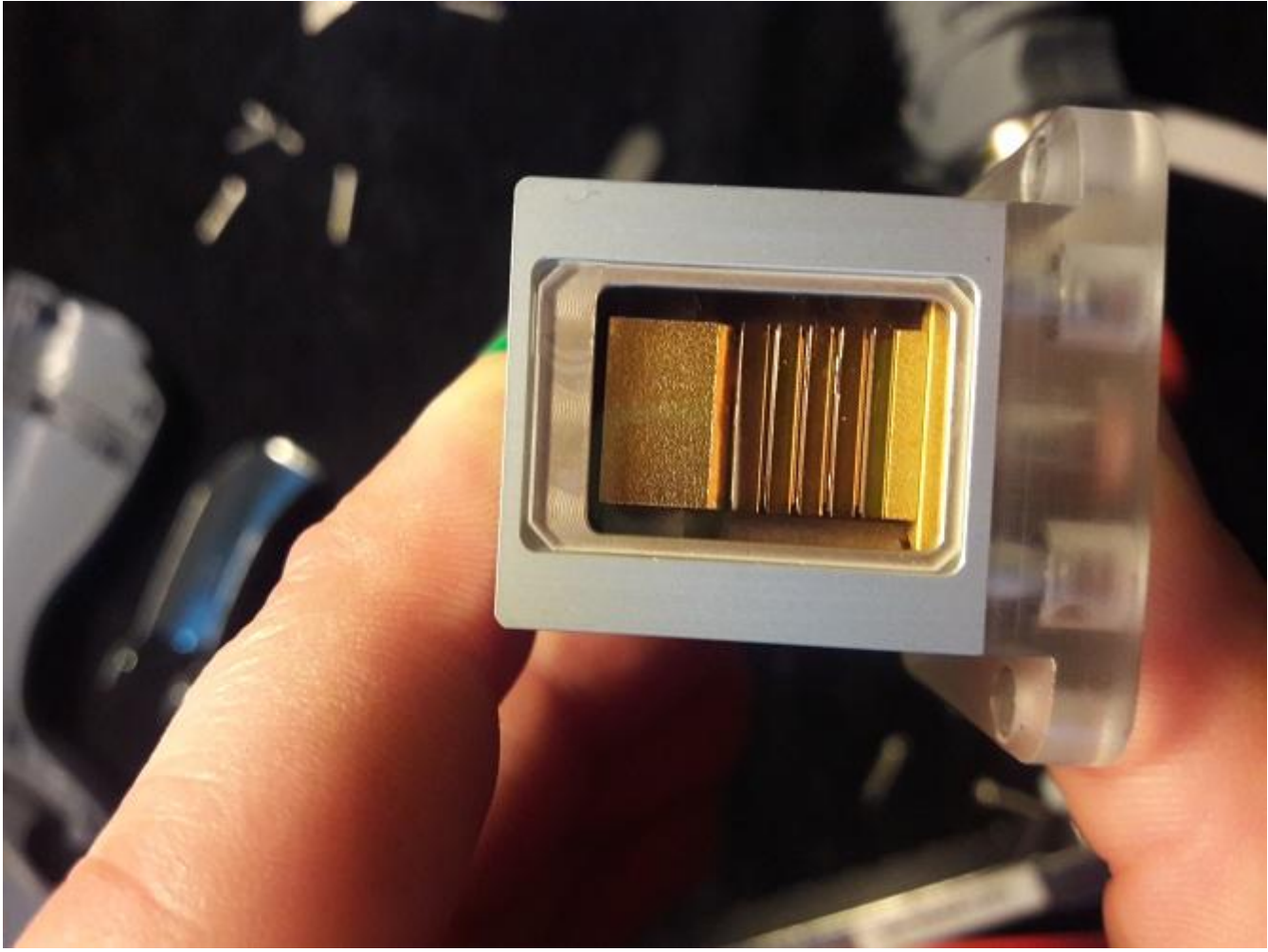



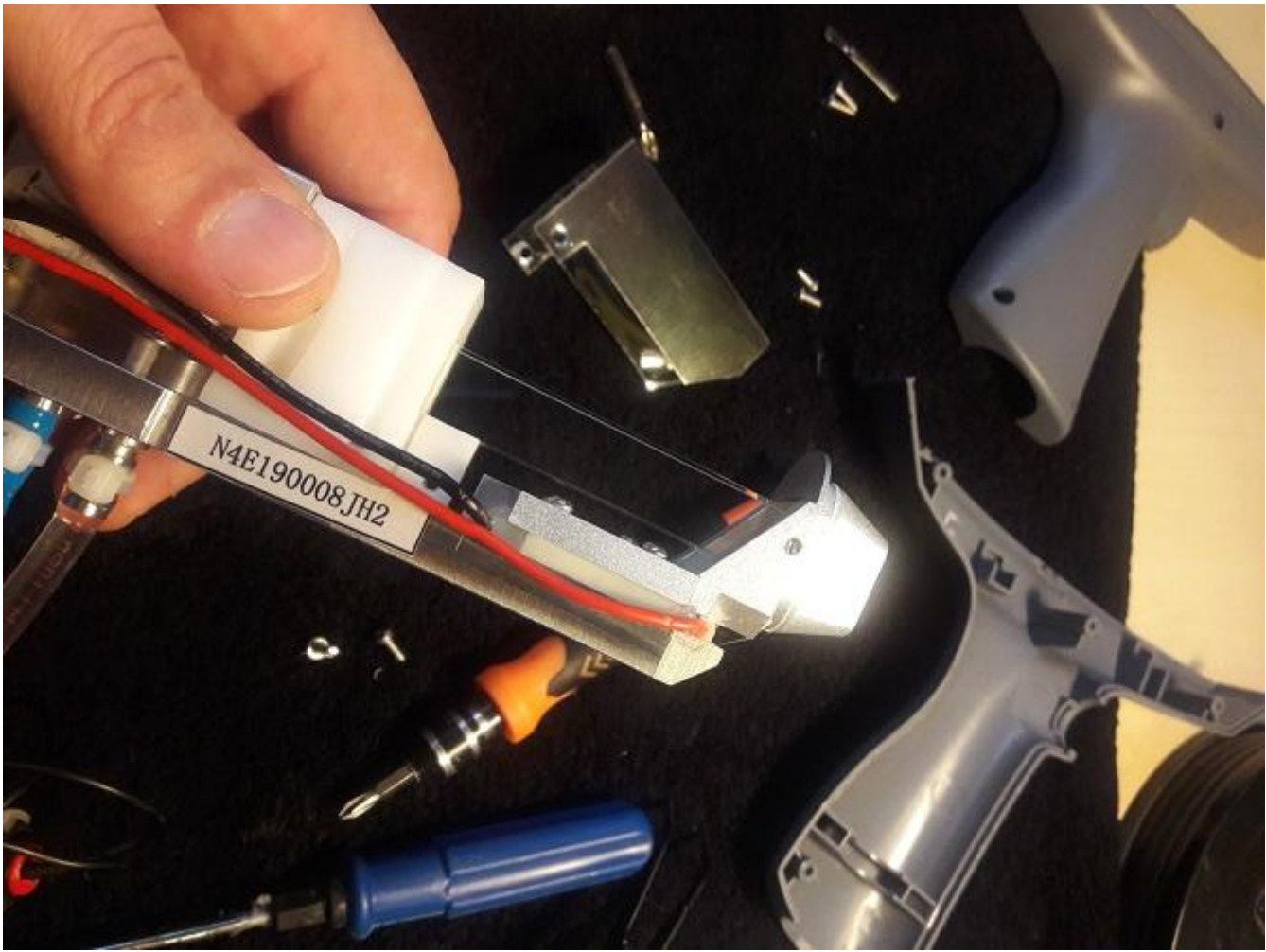



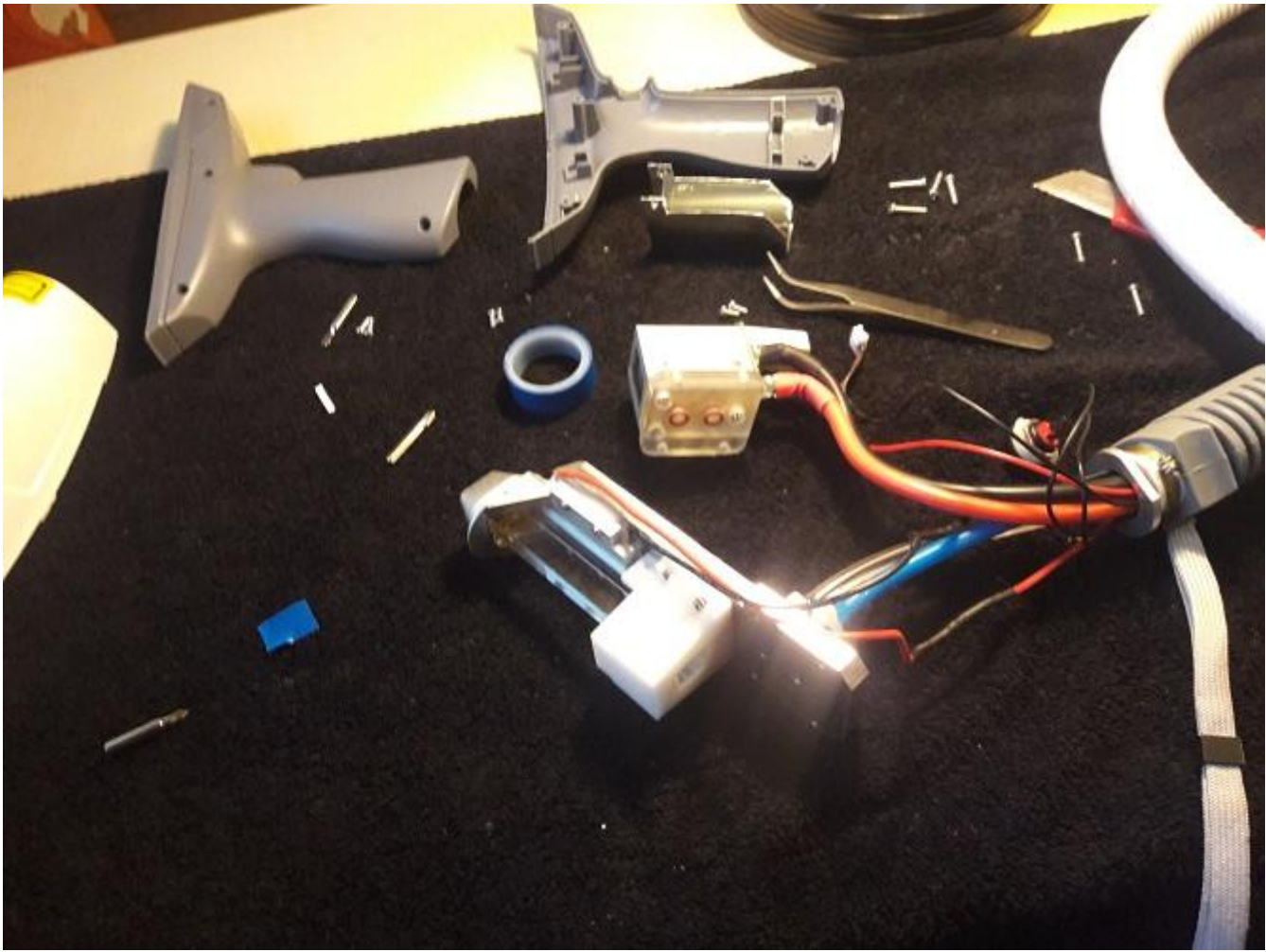

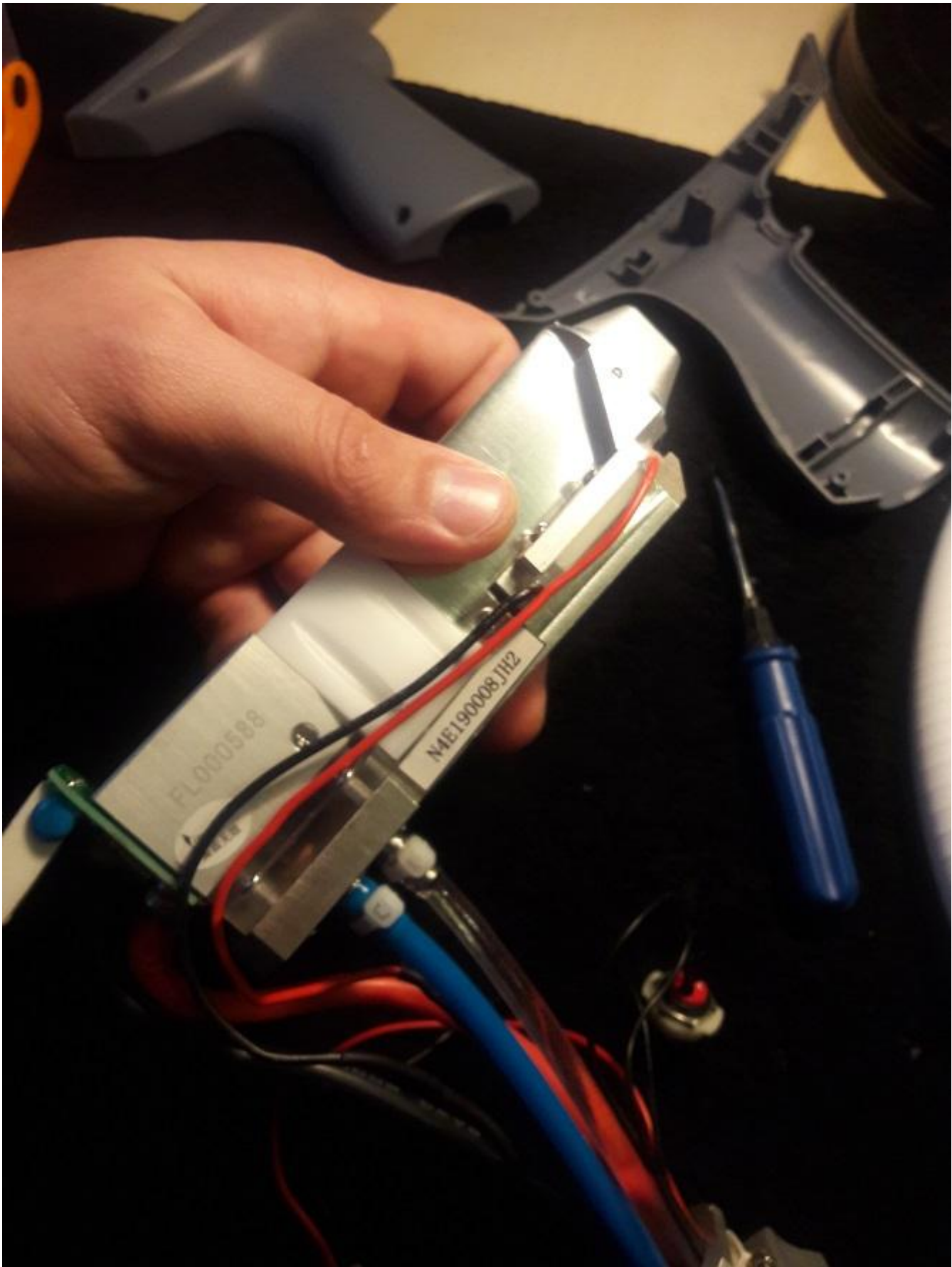







Diode laser + E-light + Nd yag laser + ICE RF

Most Advanced Technology
First Real 4 in 1





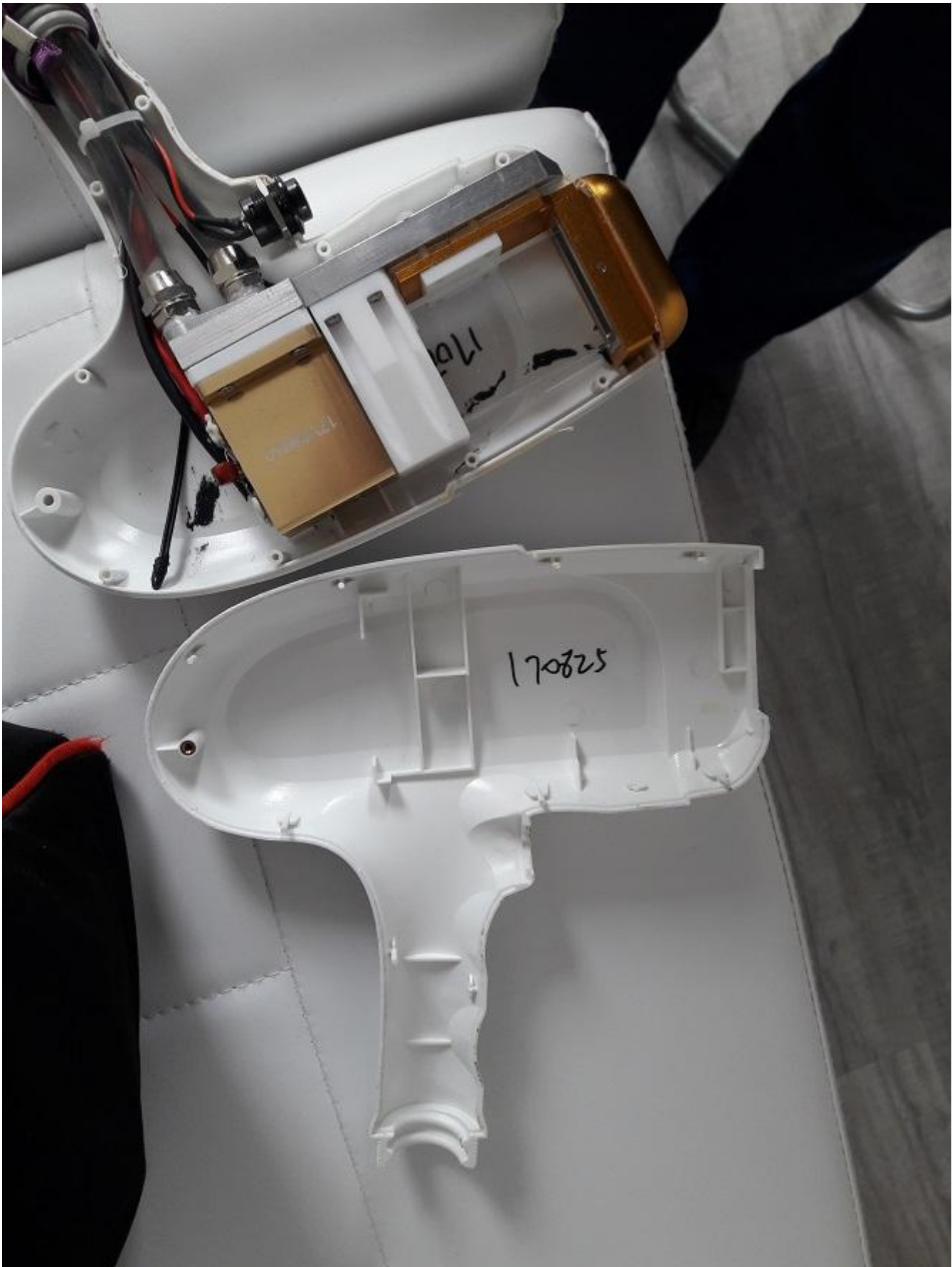



2019/12/5 12:23

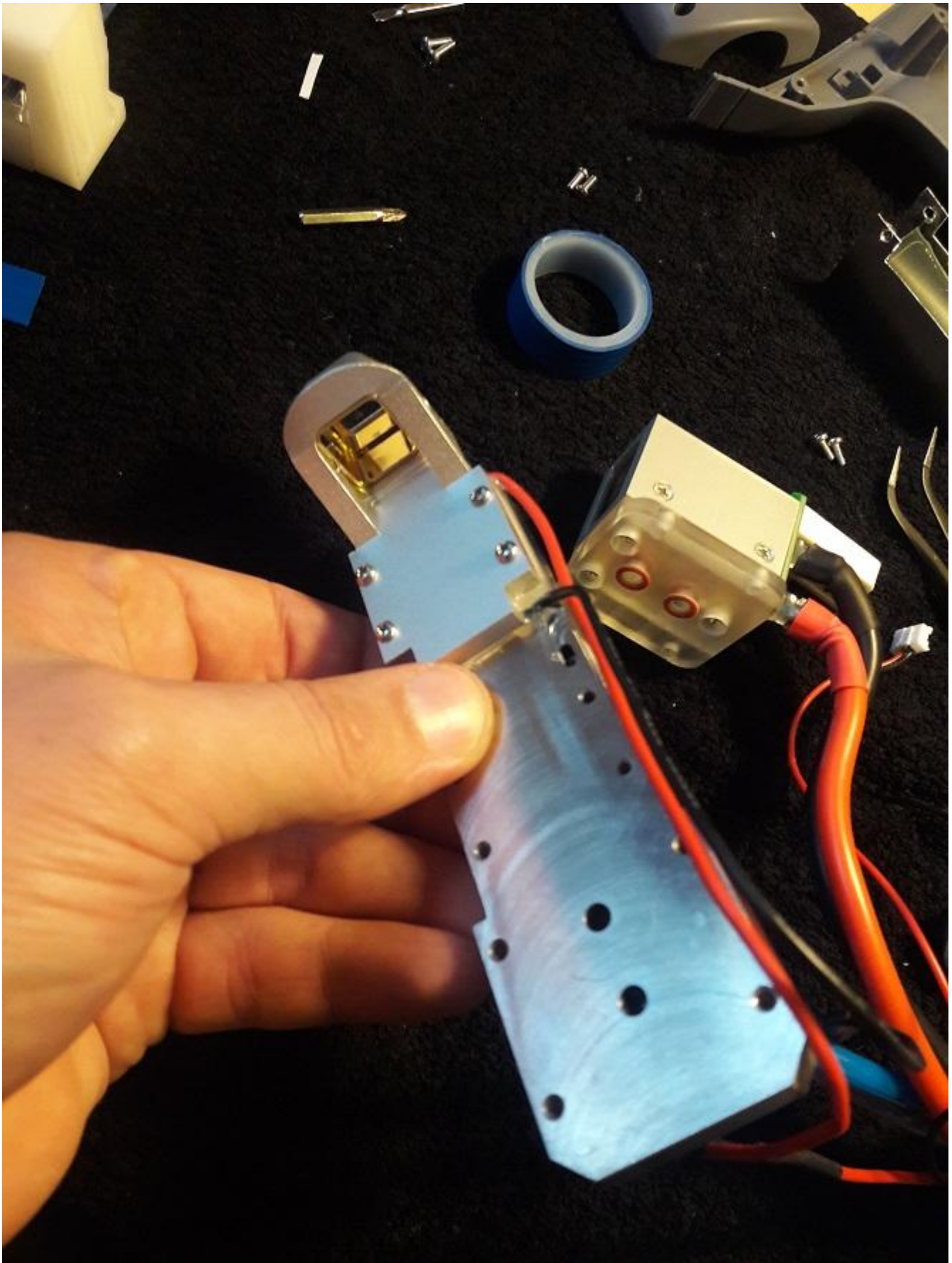



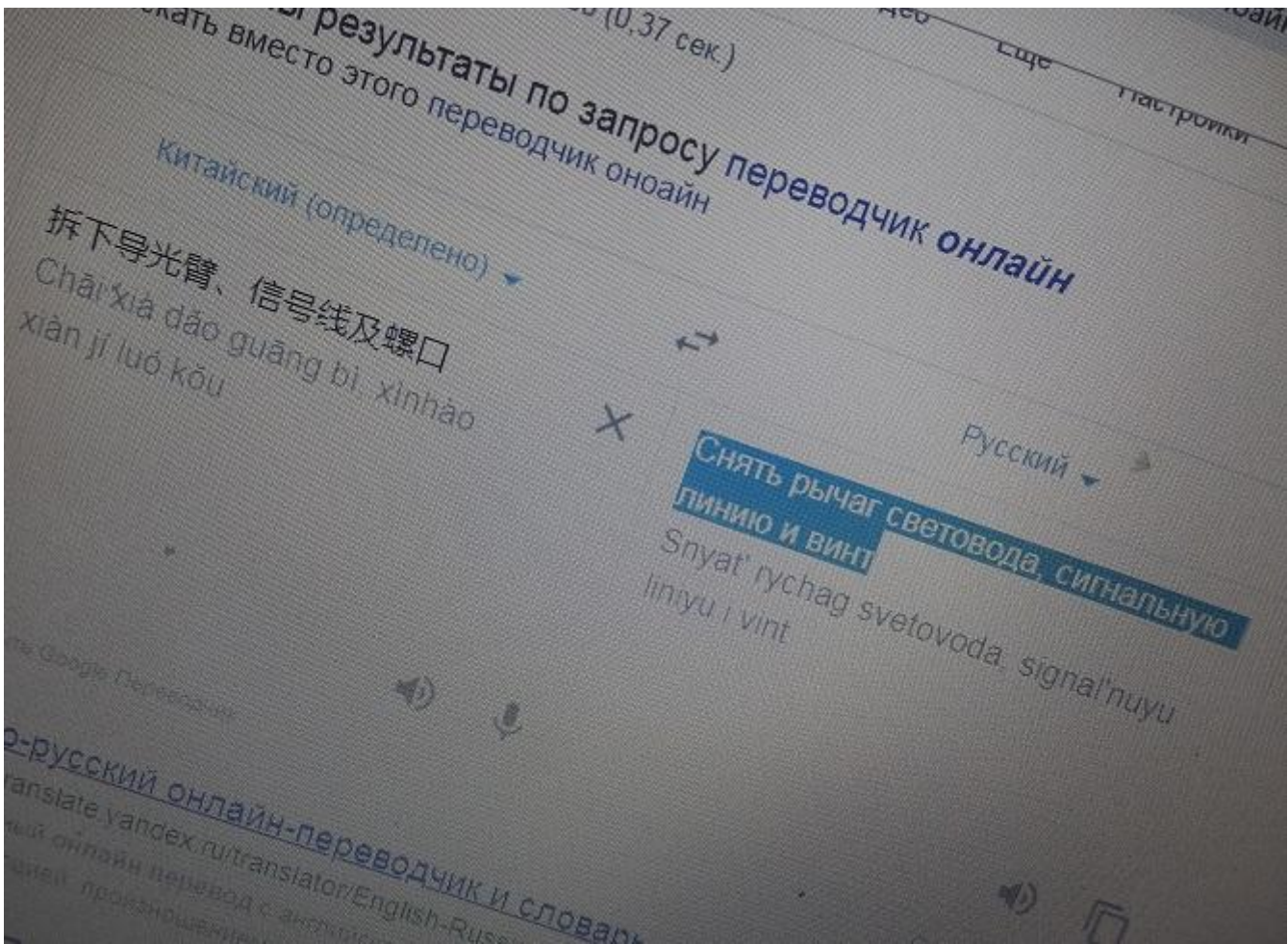
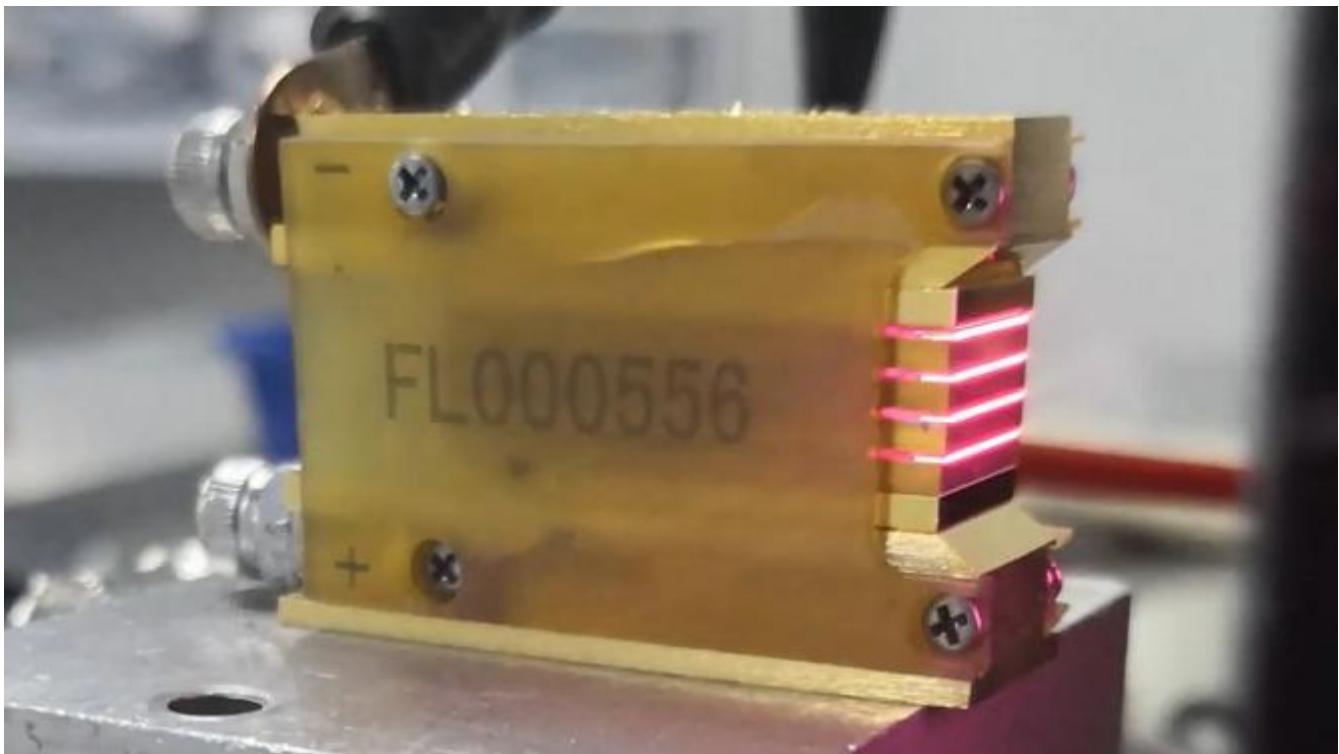





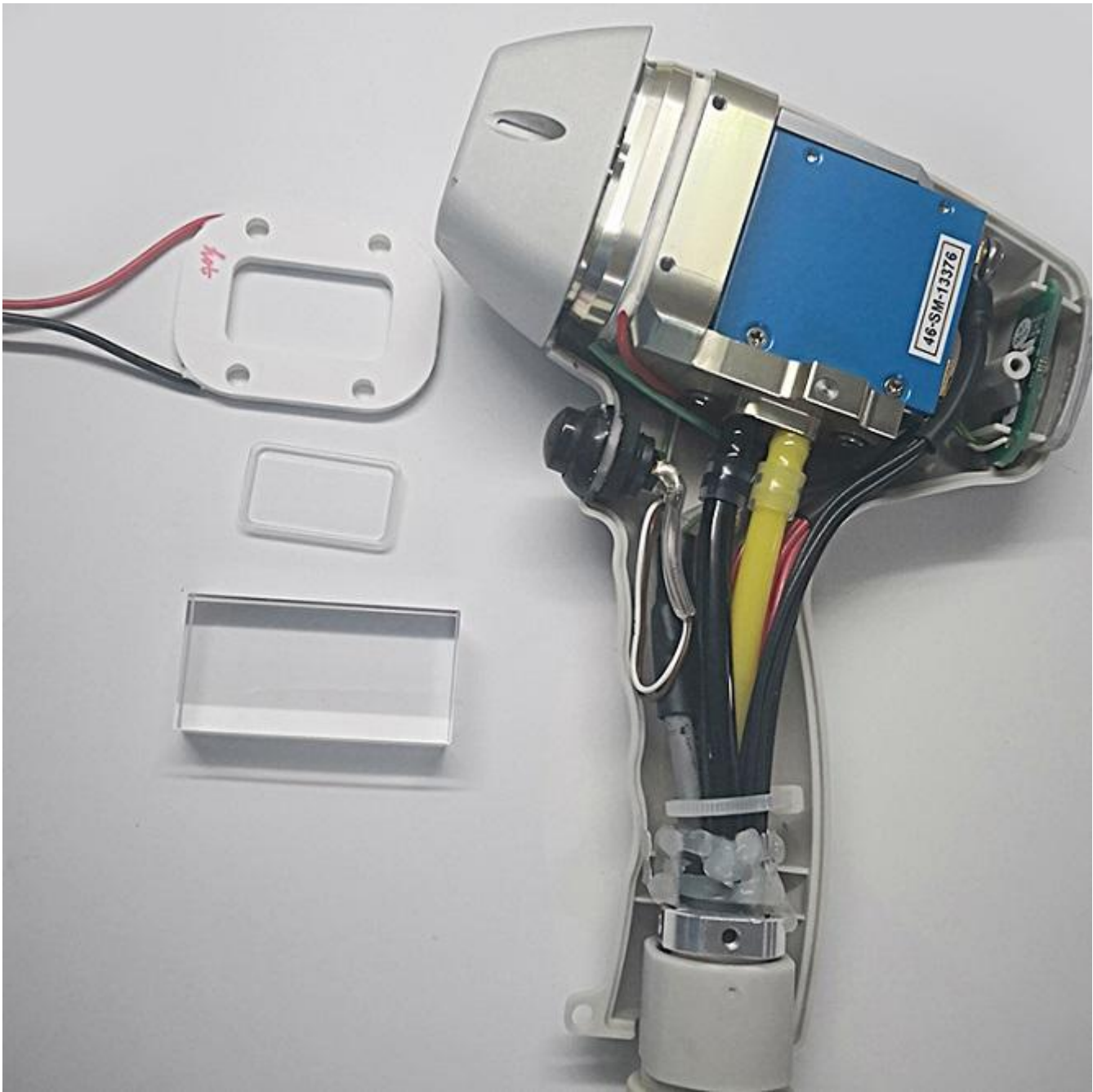



Micro-channel Water Cooled Vertical Stack Diode Laser Internal Construction

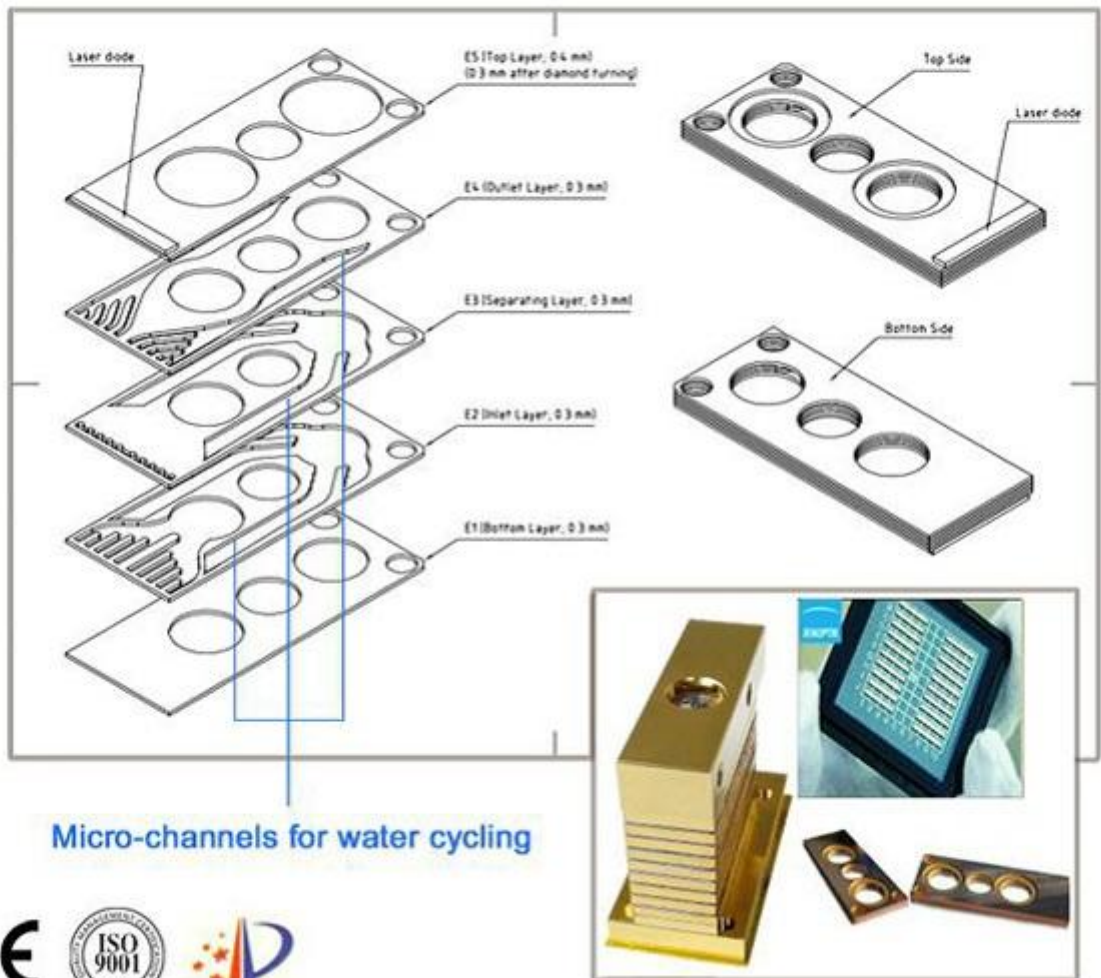

Micro-channels for water cycling



Продажа матрицы для диодного лазера любого типа. Вы можете заказать диодные сборки (выбор по мощности,барам)и другие запчасти и комплектующие для ремонта и восстановления работоспособности диодного лазера . Универсальные манипулы на диодный лазер. Ремонт лазеров и оборудования для диодной эпиляции.

Доставка в любой город России:Азов, Александров, Алексин, Альметьевск, Анапа, Ангарск, Анжеро-Судженск, Апатиты, Арзамас, Армавир, Арсеньев, Артем, Архангельск, Асбест, Астрахань, Ачинск, Балаково, Балахна, Балашиха, Балашов,Барнаул, Батайск, Белгород, Белебей, Белово, Белогорск (Амурская область),Белорецк,Белореченск, Бердск, Березники, Березовский (Свердловская область),Бийск,Биробиджан, Благовещенск (Амурская область), Бор, Борисоглебск,Боровичи, Братск, Брянск, Бугульма, Буденновск,Бузулук, Буйнакск,Великие Луки, Великий Новгород , Верхняя Пышма, Видное,Владивосток,Владикавказ, Владимир яолгоград, Волгодонск, Волжск, Волжский, Вологда, Вольск, Воркута, Воронеж, Воскресенск, Воткинск, Всеволожск,Выборг,Выкса, Вязьма,Гатчина, Геленджик,Георгиевск, Глазов, Горно-Алтайск, Грозный Губкин, Гудермес, Гуково, Гусь-Хрустальный, Дербент, Дзержинск, Димитровград, Дмитров, Долгопрудный, Домодедово,Донской, Дубна,Евпатория Егорьевск,Ейск, Екатеринбург, Елабуга,Елец,Ессентуки,Железногорск (Красноярский край),Железногорск (Курская область),Жигулевск Жуковский, Заречный, Зеленогорск, Зеленодольск, Златоуст, Иваново, Ивантеевка, Ижевск, Избербаш, Иркутск, Искитим, Ишим, Ишимбай, Йошкар-Ола, Казань Калининград, Калуга, Каменск-Уральский, Каменск-Шахтинский, Камышин, Канск, Каспийск, Кемерово, Керчь, Кинешма, Кириши, Киров (Кировская область), Кирово-Чепецк, Киселевск, Кисловодск, Клин, Клинцы, Ковров, Когалым, Коломна, Комсомольск-на-Амуре, Копейск, Королев Кострома, Котлас, Красногорск, Краснодар, Краснокаменск, Краснокамск, Краснотурьинск, Красноярск, Кропоткин, Крымск, Кстово, Кузнецк, Кумертау, Кунгур, Курган, Курск, Кызыл, Лабинск, Лениногорск, Ленинск-Кузнецкий, Лесосибирск, Липецк, Лиски, Лобня, Лысьва, Лыткарино, Люберцы Магадан, Магнитогорск, Майкоп, Махачкала, Междуреченск, Мелеуз, Миасс, Минеральные Воды, Минусинск, Михайловка, Михайловск

(Ставропольский край), Мичуринск, Москва, Мурманск, Муром, Мытищи, Набережные Челны, Назарово, Назрань, Нальчик, Наро-Фоминск, Находка, Невинномысск, Нерюнгри, Нефтекамск, Нефтеюганск, Нижневартовск, Нижнекамск, Нижний Новгород, Нижний Тагил, Новоалтайск

Новокузнецк, Новокуйбышевск, Новомосковск, Новороссийск, Новосибирск, Новотроицк, Новоуральск, Новочебоксарск, Новочеркасск, Новошактинск, Новый Уренгой, Ногинск, Норильск, Ноябрьск, Нягань, Обнинск, Одинцово, Озерск (Челябинская область), Октябрьский, Омск, Орел, Оренбург, Орехово-Зуево, Орск, Павлово, Павловский Посад, Пенза, Первоуральск, Пермь, Петрозаводск, Петропавловск-Камчатский, Подольск, Полевской, Прокопьевск, Прохладный, Псков, Пушкино, Пятигорск, Раменское, Ревда, Реутов, Ржев, Рославль, Россось, Ростов-на-Дону, Рубцовск, Рыбинск, Рязань, Салават, Сальск, Самара, Санкт-Петербург, Саранск, Сарapul, Саратов, Саров, Свободный, Севастополь, Северодвинск, Северск, Сергиев Посад, Серов, Серпухов, Сертолово, Сибай, Симферополь, Славянск-на-Кубани, Смоленск, Соликамск, Солнечногорск, Сосновый Бор, Сочи, Ставрополь, Старый Оскол, Стерлитамак, Ступино, Сургут, Сызрань, Сыктывкар, Таганрог, Тамбов, Тверь, Тимашевск, Тихвин, Тихорецк, Тобольск, Тольятти, Томск, Троицк, Туапсе, Туймазы, Тула, Тюмень, Узловая, Улан-Удэ, Ульяновск, Урус-Мартан, Усолье-Сибирское, Уссурийск, Усть-Илимск, Уфа, Ухта, Феодосия, Фрязино, Хабаровск, Ханты-Мансийск, Хасавюрт, Химки, Чайковский, Чапаевск, Чебоксары, Челябинск, Черемхово, Череповец, Черкесск, Черногорск, Чехов, Чистополь, Чита, Шадринск, Шали, Шахты, Шуя, Щекино, Щелково, Электросталь, Элиста, Энгельс, Южно-Сахалинск, Юрга, Якутск, Ялта, Ярославль.

Categories

laser hair removal machine
808nm Diode Laser Bar & Repair
808nm Diode Laser Stack & Repair
808nm Laser Handpiece Parts
808nm diode laser Power supply
808nm Diode Laser LCD&Control Board
808nm Water Radiator/Electric Fan
808nm compressor cooler/ peltier cooler
808nm diode laser goggles
808nm diode laser flow sensor
808nm diode laser temperature sensor
808nm diode laser water pump
808nm diode laser water filter
808nm water valve CPC
1060nm Laser Body Sculpture
755nm alexander diode laser stack/handpiece
1060nm Yag diode laser stack /handpiece
3 wavelength mix diode laser stack
808nm laser hair removal home use machine
SculpSure 1060nm body slimming handpiece and set
IPL Xenon Lamp
Beijing Ncrio

German Heraeus

Shanghai SK

UK First Light Lamps

US APT xenon lamp

US Excelitas

Alma Laser black widen spectacle frame soft pc protect glasses for 808nm 1064nm 755nm laser hair removal patient
black widen spectacle frame soft pc protect glasses for 808nm 1064nm 755nm laser hair removal patient
Feature: widen spectacle-frame. more comfortable
Material: soft plastic
Application: protection from ..

5.54

CW 100w Diode laser on MCC: MI100-1.5

CW 100w Diode laser on MCC: MI100-1.5

This unmounted Single 100W laser diode is used for diode laser hair removal machine .Also it can be ..
335.00

1 water pump set for diode laser hair removal machine

1 water pump set for diode laser hair removal machine

water pump Application: Used in 808nm 755nm 1064nm trio laser diode laser hair removal machine, to t..

38.00

10bars 500w macro channel 808nm diode laser hair removal handle repair

10bars 500w macro channel 808nm diode laser hair removal handle repair

10bars 500w 808nm diode laser module Description This 808 handpiece model G repair on..

1,000.00

12 bars 1200w 808nm diode laser hair removal laser stack Micro channel cooled

12 bars 1200w 808nm diode laser hair removal laser stack Micro channel cooled

808nm wavelength is the classic wavelength in laser hair removal. The 808nm wavelength offers deep pe..

5,528.00

3 combined wavelengths 755 808 1064 trio laser hair removal machine diode laser

3 combined wavelengths 755 808 1064 trio laser hair removal machine diode laser

trio laser diode Application: 1. The laser stack is used for our 755 808 1064 diode laser hair removal..

2,080.00

3 water pump set
3 water pump set
water pump Application: Used in 808nm 755nm 1064nm trio laser diode laser hair removal machine, to t..

112.00

3/8 HOSE BARB VALVED PANEL MOUNT COUPLING INSERT PLCD42006
3/8 HOSE BARB VALVED PANEL MOUNT COUPLING INSERT PLCD42006
ModelPLCD42006Material AcetalMaterial FinishNaturalPressure RangeVacuum to 120 psi, 8.3barColorwhite..

27.00

4bar micro channel diode laser stack for hair removal laser handpiece
4bar micro channel diode laser stack for hair removal laser handpiece
Spare parts for 4bar diode laser stack Itemnamematerialsize1positive electrodebrass with gold p..

1,550.00

5 bars macro channel laser stack repair for Belle laser handle
5 bars macro channel laser stack repair for Belle laser handle
After some days working, your handle laser diode stack may broken as these:Oriental-laser offer you ..

2,650.00

5 water pump set for diode laser hair removal machine
5 water pump set for diode laser hair removal machine
water pump Application: Used in 808nm 755nm 1064nm trio laser diode laser hair removal machine, to t..

175.00

5/16 HOSE BARB VALVED PANEL MOUNT COUPLING INSERT PLCD42005
5/16 HOSE BARB VALVED PANEL MOUNT COUPLING INSERT PLCD42005
1. Suittable for a wide variety of applications in pharmaceutical, food and beverage, labaratory, ch..

27.00

6 water pump set
6 water pump set
Application: Used in diode laser hair removal machine, to transfer the water, make a water circle fo..

218.00

600w Water chiller with compressor and radiator and fans and pump
600w Water chiller with compressor and radiator and fans and pump
Specification:ModelOLC-600Cooling Capacity600wPower input425wTank cubage2LDimension310x320x560Packin..

2,788.00

60w diode laser on MCC: SPMI-808-60-1.5
60w diode laser on MCC: SPMI-808-60-1.5
60w diode laser on MCC Product descriptionSpecifications:Model no SPMI-808-100-2.0CoolingG..

350.00

6A/14.6V/50.8w Alma laser Soprano ice handle use peltier cells TEC cooler
6A/14.6V/50.8w Alma laser Soprano ice handle use peltier cells TEC cooler
Alma laser Soprano ice peltier cells specification current: 6A voltage: 14.6V ..

56.50

7 in 1 pack 808nm 6*100W micro channel Diode laser hair removal Oem pack by Oriental-laser

7 in 1 pack 808nm 6*100W micro channel Diode laser hair removal Oem pack by Oriental-laser
Sales volume Top 1. The best stability and long life time up to 40 millions shots. With this pack, you..

2,180.00

7 water pump set
7 water pump set

Application: Used in diode laser hair removal machine, to transfer the water, make a water circle fo..

254.00

808 handpiece model E repair only-honkon
808 handpiece model E repair only-honkon

Oriental-laser uses high quality Germany Jenoptik diode bar, imported Micro channel cooler and advan..

2,200.00

808nm diode laser handle contacting spot structure covered by gold
808nm diode laser handle contacting spot structure covered by gold
808nm diode laser handle contacting spot structure covered by gold 1.Handle contacting sp..

135.00

810nm wavelength 20mm*30mm big spot handle shell of diode laser hair removal machine
810nm wavelength 20mm*30mm big spot handle shell of diode laser hair removal machine
810nm wavelength 20mm*30mm big spot handle shell of diode laser hair removal machineNamebig spot La..

20.00

9 in 1 808nm 6*100W micro channel Diode laser hair removal Oem pack by Oriental-laser
9 in 1 808nm 6*100W micro channel Diode laser hair removal Oem pack by Oriental-laser
Sales volume Top 1. The best stability and long life time up to 40 millions shots. With this pack, you..

2,300.00

A set of filters of diode laser hair removal machines
A set of filters of diode laser hair removal machines

Application: Used in diode laser hair removal machine, to filter the DI water. This set of filters in..

65.00

alma soprano ice platinum 808nm 810nm laser hair removal handle use sapphire Crystal Light Guide
alma soprano ice platinum 808nm 810nm laser hair removal handle use sapphire Crystal Light Guide
Size: 46.7mm*23mm*12mmsapphire crystal light guide CharacteristicsThe sapphire crystal light..

50.00

alma spa sapphire Crystal Light Guide soprano ice 808nm 810nm laser hair removal handle repair
alma spa sapphire Crystal Light Guide soprano ice 808nm 810nm laser hair removal handle repair
Size: 46.5mm*23.5(11)mm*12mmalma spa sapphire crystal light guide CharacteristicsThe sapph..

50.00

Alma spare parts water cooling plate of Alma laser handle repair use and Alma Laser Soprano XL / ICE / XLi refurbishment service
Alma spare parts water cooling plate of Alma laser handle repair use and Alma Laser Soprano XL / ICE / XLi refurbishment service
Alma spare parts water cooling plate of Alma laser handle repair use and Alma Laser Soprano XL / ICE..

245.00

black soft protect glasses ipl OPT diode laser hair removal patient use price
black soft protect glasses ipl OPT diode laser hair removal patient use price
Feature: soft pc, circle, pink, comfortableMaterial: soft plasticApplication: protection from diode ..

6.92

customers use Professional diode laser safe goggles for laser hair removal
customers use Professional diode laser safe goggles for laser hair removal
IPL laser safety goggles, laser glasses, laser safety glasses, protect wavelength: 755nm, 808nm, ..

5.00

DC Voltage 12V Single Output Switching Power Supply 150W LRS-150-12
DC Voltage 12V Single Output Switching Power Supply 150W LRS-150-12
Features•AC input range selectable by switch•Withstand 300VAC surge input for 5 second•No load power..

0.00

Economic version of OEM pack special offer
Economic version of OEM pack special offer
OEM Pack Including:1.Newest control board from oriental-laser. output 0-24V 0-50A2.Screen 10.4..

320.00

Electric fan
Electric fan
Brand : DELTA Model: AFB1212VHSize: 120*120*25.4mmVoltage: 12vOperating voltage range: 7-13.8vI..

6.00

Emergency switch
Emergency switch
Brand : CHNTModel: BE102-2It used for vertical / portable medical/aesthetic laser machine, whe..

5.00

Factory price laser hair removal 600W Single Output power supply
Factory price laser hair removal 600W Single Output power supply
Features•AC input active surge current limiting•AC input range selected by switch•Protections:Short ..

100.00

Ft110 water sensor
Ft110 water sensor
Ft110 water sensor with fast water pipe connector5V, 3 wiresHigh precision..

95.00

Golden part for laser hair removal handle designed and produced by Oriental-laser
Golden part for laser hair removal handle designed and produced by Oriental-laser
This Golden part is made with gold-plated copper, it&n..

135.00

Hand piece connector
Hand piece connector
Model Dsuitable for most of machine from Oriental-laser..

28.00

Handpiece connector for variety wavelength diode laser hair removal machine
Handpiece connector for variety wavelength diode laser hair removal machine
Handpiece connector picture:Handpiece electricity connection schemeWith the following scheme , you ca..

37.00

high quality 12V 10A TEC Thermoelectric Cooler Peltier for laser hair removal handle piece use
high quality 12V 10A TEC Thermoelectric Cooler Peltier for laser hair removal handle piece use
Product Description of TECDimensions: 25 * 25 * 3.1mmVmax: 12VImax: 10ARed line is positive, black l..

14.50

high quality laser hair removal machine spare parts foot pedal Controler
high quality laser hair removal machine spare parts foot pedal Controler
Namehigh quality laser hair removal machine spare parts foot pedal Controler for saleVoltage250VCurr..

5.00

High quality profession Protective glasses goggles for 808nm diode laser hair removal machine use
High quality profession Protective glasses goggles for 808nm diode laser hair removal machine use
OL02 Wide Spectrum Continuous Absorption Laser Safety Goggles is a highly efficient, explosion-..

45.00

High quality Protective glasses for ipl diode laser beauty device
High quality Protective glasses for ipl diode laser beauty device
IPL laser safety goggles, laser glasses, laser safety glasses,protect wavelength: 755nm, 808nm, ..

18.00

Ion-excahnge water filter for Deionized water of diode laser machine
Ion-excahnge water filter for Deionized water of diode laser machine
ion-excahnge water filterBig volume of ion-exchange. change 1 times/year or upon conditionFast conne..

33.00

Key switch
Key switch
Brand :CHNT Model: BE1013-4It used for vertical / portable diode laser hair removal machine tu..

5.00

Large spot 600w 808nm handpiece permanent diode laser hair removaltack
Large spot 600w 808nm handpiece permanent diode laser hair removaltack
Description:Wavelength: 808nmLaser power: 600WLaser bar: Germany Jenoptik barLaser stack: Micro chan..

2,788.00

laser diode hair removal controller board
laser diode hair removal controller board
Controller board is designed by Oriental-laser R&D department which can be installed to th..

200.00

Laser diode stack 808nm 755nm or 1064nm for epilator machine
Laser diode stack 808nm 755nm or 1064nm for epilator machine
Specifictaions:Model NoVS-MI-808-100-5-N1ApplicationDiode laser 808nm 7 bars 420w and 700w optional ..

3,120.00

Laser hair remmoval machine spare parts 8mm CPC plastic?connector?for water circulation
Laser hair remmoval machine spare parts 8mm CPC plastic?connector?for water circulation
Model NumberOLCPC-8Size(Male)4.7cm*2.1cmmax caliber:10mm min caliber:3.5m..

16.00

laser hair removal 10.4 inch color touch Screen made in China

laser hair removal 10.4 inch color touch Screen made in China
part number DMT80600T104_05WTColor65K color(16bit)Horizontal resolution800Longitudinal resolution600A..

215.00

Laser hair removal machine handle piece shell for sale
Laser hair removal machine handle piece shell for sale
Applications:For 755nm/ 808nm/ 1064nm laser hair removal machine handle pieceNameLaser hair removal ..

15.00

laser hair removal machine use 600w cooling compressor
laser hair removal machine use 600w cooling compressor
Characteristics1. The cooling compressor can support the laser hair removal machine for 24 hour..

0.00

Light guide cone lens
Light guide cone lens
Description: < NameMaterialSize Light guide cone lensK9&n..

35.00

Main control board of 755nm 808nm 1064nm trio laser Diode laser hair removal machine
Main control board of 755nm 808nm 1064nm trio laser Diode laser hair removal machine
oriental-laser design control board for top quality 755nm, 808nm, 1064nm, trio laser hair removal ma..

120.00

Mean well power supply NES-100W-24V for laser hair removal system
Mean well power supply NES-100W-24V for laser hair removal system
Application:For driver water pump 3pcs kitspecification:Model No:NES-100-24power:100Wvoltage:24VPara..

0.00

Mean well power supply NES-200W-24V for laser hair removal system
Mean well power supply NES-200W-24V for laser hair removal system
Application:For driver water pump 6pcs kitspecification:Model No:NES-200-24power:200Wvoltage:24VPara..

0.00

Mean well power supply SE-1000W-12V For laser hair removal equipment
Mean well power supply SE-1000W-12V For laser hair removal equipment
Application:comply with constant current board to drive diode laser handpiece (5-6bars 100A)specific..

0.00

Mean well power supply SE-1000W-24V For laser hair removal machine
Mean well power supply SE-1000W-24V For laser hair removal machine
Application:comply with constant current board to drive diode laser handpiece (7bars 50A). spec..

0.00

Mean well power supply SE-600W-15V For laser hair removal machine
Mean well power supply SE-600W-15V For laser hair removal machine
Application:comply with constant current board to drive diode laser handpiece (7bars 50A). spec..

0.00

Ncrieo Xenon Lamp -7*65*130 with wires German quartz for IPL System
Ncrieo Xenon Lamp -7*65*130 with wires German quartz for IPL System
LAMP SPECIFICATIONSDimensionLamp's Outside dia.(OD) = 7 mm Lamp's Arc length (AL) =..

120.00

Ncrieo Xenon Lamp 7*45*90 With Wires German Quartz Cathode 90°
Ncrieo Xenon Lamp 7*45*90 With Wires German Quartz Cathode 90°
LAMP SPECIFICATIONS Dimension Lamp's Outside dia.(OD) = 7 mm Lamp's Arc length (AL) = ..

120.00

Ncrieo Xenon lamp 7*55*100 with wires German quartz
Ncrieo Xenon lamp 7*55*100 with wires German quartz
LAMP SPECIFICATIONS Dimension Lamp's Outside dia.(OD) = 7 mm Lamp's Arc length (AL) = ..

120.00

Ncrieo Xenon lamp 7*60*125 with wires Chinese quartz
Ncrieo Xenon lamp 7*60*125 with wires Chinese quartz
LAMP SPECIFICATIONS Dimension Lamp's Outside dia.(OD) = 7 mm Lamp's Arc length (AL) = ..

96.00

OEM / Repair Alma Soprano Model F 12 Bars Blue Side Plate Rectangular
OEM / Repair Alma Soprano Model F 12 Bars Blue Side Plate Rectangular
Specification Model No VS-MI-808-100-1.5-12:0-Alma-12-2 Application Alma Soprano Handle Piece Repair And..

5,528.00

OEM 10Bars Micro Channel Diode Laser Stack For Hair Removal Machine
OEM 10Bars Micro Channel Diode Laser Stack For Hair Removal Machine
OEM 10Bars Micro Channel Laser Stack Dimension..

4,188.00

OEM 6bars micro channel diode laser stack for hair removal machine
OEM 6bars micro channel diode laser stack for hair removal machine
..

2,788.00

oriental-laser 808nm 810nm 755nm 1064nm spot size 10mm*17mm laser hair removal handle use sapphire Crystal Light Guide
oriental-laser 808nm 810nm 755nm 1064nm spot size 10mm*17mm laser hair removal handle use sapphire Crystal Light Guide
Spot Size: 10mmx17mm sapphire crystal light guide size: 44.5+18(16)+13(9)sapphire crystal light guid..

25.00

oriental-laser 808nm 810nm 755nm 1064nm spot size 11mm*11mm laser hair removal handle use sapphire Crystal Light Guide
oriental-laser 808nm 810nm 755nm 1064nm spot size 11mm*11mm laser hair removal handle use sapphire Crystal Light Guide
Spot Size: 11mmx11mm sapphire crystal light guide size: 50*13(9)*13(9)sapphire crystal light guide&n..

25.00

oriental-laser spot size 10mm*17mm laser hair removal handle sapphire for sale
oriental-laser spot size 10mm*17mm laser hair removal handle sapphire for sale
Spot Size: 10mmx17mm sapphire size: 17*10*9.5sapphire Characteristics Sapphire is mainly u..

27.69

oriental-laser spot size 11mm*11mm laser hair removal handle sapphire for sale
oriental-laser spot size 11mm*11mm laser hair removal handle sapphire for sale
Spot Size: 11mmx11mm sapphire size: 11*11*9.5sapphire Characteristics Sapphire is mainly u..

24.00

oriental-laser spot size 20mm*30mm laser hair removal handle sapphire for sale
oriental-laser spot size 20mm*30mm laser hair removal handle sapphire for sale
Spot Size: 20mmx30mm sapphire size: 30*20*9.5sapphire CharacteristicsSapphire is mainly u..

36.92

Pack 8 in 1 laser hair removal handle piece 3bar diode laser for dilas laser stack repair
Pack 8 in 1 laser hair removal handle piece 3bar diode laser for dilas laser stack repair
Pack 8 in 1 DimensionItemNameMaterialSize11 and 5Side platealuminum colorless oxidationSize: 5..

1,580.00

pink soft protect goggles for ipl OPT diode laser hair removal patient
pink soft protect goggles for ipl OPT diode laser hair removal patient
Feature: soft pc, circle, pink, comfortableMaterial: soft plasticApplication: protection from diode ..

6.92

PP filter
PP filter
Application: Used in diode laser hair removal machine, to filter the DI water.This PP filter is used..

6.00

protect laser glasses for OPT IPL 808nm laser operator Model B
protect laser glasses for OPT IPL 808nm laser operator Model B
IPL laser safety goggles, laser glasses, laser safety glasses, Laser safety glasses is very nee..

7.48

protect laser goggles for diode laser, OPT, IPL, YAG Laser operator Model A
protect laser goggles for diode laser, OPT, IPL, YAG Laser operator Model A
IPL laser safety goggles, laser glasses, laser safety glasses,protect wavelength:200nm-2000nmprotect..

7.48

quartz crystal light guide window for 755nm alma soprano laser hair removal handle use
quartz crystal light guide window for 755nm alma soprano laser hair removal handle use
Alma laser 755nm quartz crystal Size: 19.9(18.4)mm15.9(14.4)mm3mmThe quartz crystal window is for 75..

50.00

quartz crystal window alma soprano ice platinum quartz crystal light guide 808nm 810nm laser hair removal handle use
quartz crystal window alma soprano ice platinum quartz crystal light guide 808nm 810nm laser hair removal handle use
Alma laser 810nm quartz crystal Size: 27.9(25.4)mm*15.9(14.4)mm*3mmThe quartz crystal window is..

50.00

sapphire Crystal Light Guide alma soprano ice 810nm laser hair removal handle repair
sapphire Crystal Light Guide alma soprano ice 810nm laser hair removal handle repair
Size: 46.5mm*23(16)mm*12mmsapphire crystal light guide CharacteristicsThe sapphire crystal..

50.00

SE-600-12 600W Single Output power supply medical applications 12V
SE-600-12 600W Single Output power supply medical applications 12V
Features•AC input active surge current limiting•AC input range selected by switch•Protections:Short ..

0.00

Shanghai SK Xenon lamp, 7*50*115, with wires for IPL Machine

Shanghai SK Xenon lamp, 7*50*115, with wires for IPL Machine
LAMP SPECIFICATIONS Dimension Lamp's Outside dia.(OD) = 7 mm Lamp's Arc length (AL) = ..

55.00

SK Xenon Flash Lamp, 7*60*125, with wires for IPL
SK Xenon Flash Lamp, 7*60*125, with wires for IPL
LAMP SPECIFICATIONS Dimension Lamp's Outside dia.(OD) = 7 mm Lamp's Arc length (AL) = ..

55.00

SK Xenon Flash Lamp, 8*50*110, with wires For IPL System
SK Xenon Flash Lamp, 8*50*110, with wires For IPL System
LAMP SPECIFICATIONS Dimension Lamp's Outside dia.(OD) = 8 mm Lamp's Arc length (AL) = ..

85.00

SK Xenon lamp 6*50*86, With Wires For IPL Machine
SK Xenon lamp 6*50*86, With Wires For IPL Machine
LAMP SPECIFICATIONS Dimension Lamp's Outside dia.(OD) = 6 mm Lamp's Arc length (AL) = ..

96.00

SK Xenon Lamp 7*50*110*130, with caps, Japanese quartz
SK Xenon Lamp 7*50*110*130, with caps, Japanese quartz
LAMP SPECIFICATIONS Dimension Lamp's Outside dia.(OD) = 7 mm Lamp's Arc length (AL) = ..

96.00

SK Xenon Lamp, 9*65*142, with wires for IPL
SK Xenon Lamp, 9*65*142, with wires for IPL
LAMP SPECIFICATIONS Dimension Lamp's Outside dia.(OD) = 9 mm Lamp's Arc length (AL) = ..

55.00

spot size 20*30mm 808nm 810nm oriental laser hair removal handle use sapphire Crystal Light Guide
spot size 20*30mm 808nm 810nm oriental laser hair removal handle use sapphire Crystal Light Guide
laser handle spot size: 20*30mm sapphire crystal Size: 67(28)+24(18)+13 sapphire crystal lig..

46.00

Structure part of Oriental-laser 6 bars Micro channel cooled laser stack
Structure part of Oriental-laser 6 bars Micro channel cooled laser stack
Description: These parts are Positive, Negative and Laser stack cover. It is used to make the st..

3,788.00

Temperature sensor
Temperature sensor
* DS18B20, 1 meter* mostly used in various control board* Suitable for laser hair removal control bo..

2.00

Temperature sensor for Oriental-laser controller board diode laser hair removal machine
Temperature sensor for Oriental-laser controller board diode laser hair removal machine
The length of temperature sensor is 1 meter Application: It is suitable for laser hair removal controller..

6.80

The Frame for portable diode laser hair removal machine
The Frame for portable diode laser hair removal machine
We can provide you the frame and whole spare parts kit for install diode laser hair removal machine ..

89.00

UK Firstlight Lamp, F703, 7*60*124, with wires
UK Firstlight Lamp, F703, 7*60*124, with wires
LAMP SPECIFICATIONS Dimension Lamp's Outside dia.(OD) = 7 mm Lamp's Arc length (AL) =..

150.00

UK Firstlight Xenon Lamp F1106 , 7*50*110, with wires for IPL
UK Firstlight Xenon Lamp F1106 , 7*50*110, with wires for IPL
LAMP SPECIFICATIONS Dimension Lamp's Outside dia.(OD) = 7 mm Lamp's Arc length (AL) =..

150.00

UK Firstlight Xenon Lamp F1185B, 7*50*90, with wires, cathode 90°
UK Firstlight Xenon Lamp F1185B, 7*50*90, with wires, cathode 90°
LAMP SPECIFICATIONS Dimension Lamp's Outside dia.(OD) = 7 mm Lamp's Arc length (AL) =..

150.00

UK Firstlight Xenon Lamp, F1215, 7*70*127, with wires For IPL Machine
UK Firstlight Xenon Lamp, F1215, 7*70*127, with wires For IPL Machine
LAMP SPECIFICATIONS Dimension Lamp's Outside dia.(OD) = 7 mm Lamp's Arc length (AL) =..

150.00

UK Firstlight Xenon Lamp, F981, 7*65*130, with wires
UK Firstlight Xenon Lamp, F981, 7*65*130, with wires
LAMP SPECIFICATIONS Dimension Lamp's Outside dia.(OD) = 7 mm Lamp's Arc length (AL) =..

150.00

ultra sense 500 m lazer hair removal machine ultra sense 500 diode laser handpiece use laser diode
ultra sense 500 m lazer hair removal machine ultra sense 500 diode laser handpiece use laser diode
Specification Model MI-100-5-Dilas-808 Number of bars 5 Bars Single bar power 100W Wavelength 808nm Operation ..

1,880.00

US APT Xenon Flash Lamp , XP-470, 7*65*130 with wires
US APT Xenon Flash Lamp , XP-470, 7*65*130 with wires
LAMP SPECIFICATIONS Dimension Lamp's Outside dia.(OD) = 7 mm Lamp's Arc length (AL) =..

230.00

US Excelitas, L9662, 7*65*130 with wires
US Excelitas, L9662, 7*65*130 with wires
LAMP SPECIFICATIONS Dimension Lamp's Outside dia.(OD) = 7 mm Lamp's Arc length (AL) =..

230.00

valve CPC water connector for aroma laser hair removal machine
valve CPC water connector for aroma laser hair removal machine
water connector for aroma laser hair removal machine Aroma laser hair removal machine use..

8.00

VS-MA-50-10 Model A-DVS-500-808 500w macro laser stack water holes on the back
VS-MA-50-10 Model A-DVS-500-808 500w macro laser stack water holes on the back
20v voltage 10bars 808nm diode laser stack Description This diode laser stack 10 bars Model A fo..

1,180.00

Spare Parts

Sort By:

Show:

VS-MA-50-10 Model D-GTHM-500-808 10bars macro laser module water connectors are on the side

VS-MA-50-10 Model D-GTHM-500-808 10bars macro laser module water connectors are on the side

DescriptionThis 808nm 500w diode laser stack 10 bars Model D for hair removal which has 10 bars with..

2,200.00

VS-MA-50-10 Model E-GTHM-500-808 10 bars laser diode with a aluminum shell

VS-MA-50-10 Model E-GTHM-500-808 10 bars laser diode with a aluminum shell

10bars 808nm diode laser stack DescriptionThis 808nm diode laser stack 10 bars Model E for hair..

1,180.00

VS-MA-50-10 Model G-GTHM-500-808 10bars macro diode laser with water connectors on the bottom

VS-MA-50-10 Model G-GTHM-500-808 10bars macro diode laser with water connectors on the bottom

500W 10bars diode laser stack DescriptionThis 500w diode laser stack 10bars Model G for hair re..

2,200.00

VS-MA-50-10 Model H-GTHM-500-808 aluminum shell 10 bars laser diode with water holes on the back

VS-MA-50-10 Model H-GTHM-500-808 aluminum shell 10 bars laser diode with water holes on the back

DescriptionThis diode laser stack 10 bars Model H for hair removal which has 10 bars with a aluminum..

1,180.00

VS-MA-50-10 Model I-GTHM-500-808 macro laser diode for LLD handpiece

VS-MA-50-10 Model I-GTHM-500-808 macro laser diode for LLD handpiece

DescriptionThis VS-MA-50-10 Model I-GTHM-500-808 lasertel 808nm laser diode is special laser st..

1,180.00

VS-MA-50-10 Model J-GTHM-500-808 laser components germany 808nm 810nm power laser 500w for 810 nm diode laser hair removal

VS-MA-50-10 Model J-GTHM-500-808 laser components germany 808nm 810nm power laser 500w for 810 nm diode laser hair removal

Description 808nm 810nm power laser 500w for painless laser hair removal machine useThis 808nm ..

1,000.00

VS-MA-50-32(2?16) Model A-808 32pcs diode laser of ADSS or Apolomed

VS-MA-50-32(2?16) Model A-808 32pcs diode laser of ADSS or Apolomed

DescriptionThis diode laser stack VS-MA-50-32(2?16) Model A for hair removal which has 2pcs 16bars v..

3,500.00

VS-MA-50-6-B-808 300w macro diode laser stack with big cooper heatsink

VS-MA-50-6-B-808 300w macro diode laser stack with big cooper heatsink

808 6bars diode laser handle repair DescriptionThis VS-MA-50-6-B-808 is an 808nm diode laser stack, ..

800.00

VS-MI-100-12-AlmaSoprano-A-808nm 12bars alma laser stack PEEK side plate

VS-MI-100-12-AlmaSoprano-A-808nm 12bars alma laser stack PEEK side plate

DescriptionThis VS-MI-100-12-AlmaSoprano-A is Alma Soprano 12 bar laser stack with PEEK side plate. ..

4,200.00

VS-MI-100-12-AlmaSoprano-B-808nm Alma 12bars laser stack blue side plate

VS-MI-100-12-AlmaSoprano-B-808nm Alma 12bars laser stack blue side plate

808 Alma Soprano repair DescriptionThis VS-MI-100-12-AlmaSoprano-B is Alma Soprano 12 bar laser stac..

4,200.00

VS-MI-100-12-AlmaSoprano-C-808nm 12bars alma laser stack black side plate
VS-MI-100-12-AlmaSoprano-C-808nm 12bars alma laser stack black side plate
DescriptionThis VS-MI-100-12-AlmaSoprano-C is Alma Soprano 12 bar laser stack with black side plate ..

4,200.00

VS-MI-100-12-AlmaSoprano-E-808nm 12bars Alma laser stack
VS-MI-100-12-AlmaSoprano-E-808nm 12bars Alma laser stack
DescriptionThis VS-MI-100-12-AlmaSoprano-E is Alma Soprano 12 bar laser stack with black side plate ..

4,200.00

VS-MI-100-12-AlmaSopranoICE-D-808nm 12bars soprano ice laser stack
VS-MI-100-12-AlmaSopranoICE-D-808nm 12bars soprano ice laser stack
Soprano ICE laser stack DescriptionThis VS-MI-100-12-AlmaSopranoICE-D is special laser stack fo..

4,200.00

VS-MI-100-3-Dilas-808 Dilas 300w diode laser stack
VS-MI-100-3-Dilas-808 Dilas 300w diode laser stack
Dilas laser diode SpecificationModel NoMI-100-5-Dilas-808Number of bars3 barsSingle bar power100wWav..

1,250.00

VS-MI-100-3-FL-A-808
VS-MI-100-3-FL-A-808
You may need to pay a high cost for repairing when your 810 3bars 300w aroma hair removal machine ou..

1,280.00

VS-MI-100-3-FL-B-808
VS-MI-100-3-FL-B-808
Oriental-laser uses high quality Germany Jenoptik diode bar, imported Micro channel cooler and advan..

2,200.00

VS-MI-100-4-FL-A-808
VS-MI-100-4-FL-A-808
This 400W laser diode is used for diode laser hair removal machine handpiece repair.Usage: (1)..

1,580.00

VS-MI-100-4-FL-B-808
VS-MI-100-4-FL-B-808
This 400W 808nm micro channel laser diode is used for diode laser hair removal machine handpiece rep..

1,580.00

VS-MI-100-5-Dilas-808 500w Dilas laser diode
VS-MI-100-5-Dilas-808 500w Dilas laser diode
SpecificationModelMI-100-5-Dilas-808Number of bars5 BarsSingle bar power100WWavelength808nmOperation ..

1,880.00

VS-MI-100-5-FL-A-808
VS-MI-100-5-FL-A-808
Honkon laser 808nm handle repair DescriptionThis VS-MI-100-5-FL-A is an 808nm diode laser stack, whi..

1,880.00

VS-MI-100-5-FL-B-808 Dilas 500W Laser Stack For Aroma Blue Handpiece

VS-MI-100-5-FL-B-808 Dilas 500W Laser Stack For Aroma Blue Handpiece
Aroma blue handpiece repair Description:This VS-MI-100-5-FL-B is an 808nm diode laser stack, which ha..

1,880.00

VS-MI-100-6-FL-A-808
VS-MI-100-6-FL-A-808
Description:This VS-MI-100-6-FL-A is an 808nm diode laser stack, which has 6pcs 100w bars with alumin..

1,580.00

VS-MI-100-6-FL-B-808
VS-MI-100-6-FL-B-808
KES diode laser hair removal handpiece repair Description:This VS-MI-100-6-FL-B-808 is an 808nm ..

2,200.00

VS-MI-100-8-NL3-808
VS-MI-100-8-NL3-808
808nm 8bars nlght laser stack handle Description:This VS-MI-100-8-NL3-5 includes 3 real 100w ba..

1,280.00

VS-MI-100-8-Syneron A-808 Syneron-Candala 800w laser stack
VS-MI-100-8-Syneron A-808 Syneron-Candala 800w laser stack
Syneron laser repair Description:This VS-MI-100-8-Syneron A is 8 bars laser stack special for s..

2,850.00

VS-MI-100-8-Syneron B-808 Syneron-Candala 8bars laser stack
VS-MI-100-8-Syneron B-808 Syneron-Candala 8bars laser stack
808 Syneron laser handle repair Description:This VS-MI-100-8-Syneron B is another 8 bars laser ..

2,850.00

VS-MI-60-7-NL7-808
VS-MI-60-7-NL7-808
Nlght 7bar diode laser handle repair Description:This VS-MI-60-7-NL7 is an 808nm diode laser stack,..

2,550.00

Water filter set of diode laser hair removal machine
Water filter set of diode laser hair removal machine
PP water filter and ion-exchange resin water filter. especially for micro channel hand piece is stri..

36.00

Water Flow Sensor
Water Flow Sensor
* water sensor with 2 fast water pipe connector for 10mm diameter water pipe* 5V, 3 wires* made in c..

7.50

water flow sensor for diode laser hair removal machine
water flow sensor for diode laser hair removal machine
Water flow sensor dimension:water flow sensor specification:Water flow rate1-30l/minvoltage5vModel:O..

7.50

Water flow sensor without connector
Water flow sensor without connector
5V, 3 wires..

5.00

Water radiator
Water radiator
aluminium, 273mm*120mm*30mm, without fans..

25.00 25.00

Water tank
Water tank
Size: 25*14*12mmVolume: 3LFor our portable diode laser hair removal machine..

35.00

Hand Piece
Refine Search
Oriental Laser (2)
Sort By:
Show:
2018 New 808nm Diode Laser Hair Removal handle
2018 New 808nm Diode Laser Hair Removal handle
Micro channel diode laser hair removal handle 808nm (755nm or 1064nm),with Germany imported micro ch..

2,688.00

600W real power 808nm diode laser hair removing handles for beauty machines
600W real power 808nm diode laser hair removing handles for beauty machines
Laser diode handle DescriptionThis diode handle 600W is specially designed for those manufacturer wh..

2,788.00

Лазерный диодный модуль GTHM-500 500W, GTHM-250 250W, GTHM-300 300W, GTHM-350 350W, GTHM-500 500W, GTHM-600 600W, GTHM-800 800W, <https://ali.ski/MpD9Ny> .

alibaba

Diode Laser Module <https://fas.st/ZuuKB> .

Diyot Lazer modülleri için Epilasyon

Diyot Lazer modülleri için Epilasyon

Diode Laser modules voor Ontharing

Módulos de Laser de Diodo para a Remoção Do Cabelo LSKCSH

Diode Laser Module für Haar Entfernung

Modules Laser à Diode LSKCSH pour épilation

Особенности:

1. Диодный лазерный модуль состоит из диодного лазерного массива и диодного лазерного драйвера.

2. Диодный лазерный модуль с защитным окном.

3. Симметричный луч

4. Простое водяное охлаждение и отсутствие высокого давления и воды высокого качества
5. Полностью герметичный и заполненный азотом, с сильной экологической адаптируемостью и высокой стабильностью;
6. Прямоугольный симметричный точечный выход, высокая плотность энергии, легко формируется;
7. Окно покрыто Антибликовой Пленкой для уменьшения потери мощности;
8. Структура рассеивания тепла макро-канала, простое водяное охлаждение;
9. Плата привода интегрирована и обладает высокой выходной стабильностью.

Технические характеристики:

Тип: GTNM-500

Пиковая мощность на выходе: 500 Вт

Максимальный рабочий ток: 50А

Максимальная ширина импульса: 400 мс

Максимальный рабочий цикл: 40%

Длина волны: 780-820 нм, 900- 980 нм Спецификация

товара:

Использование: Коммерческое производство Номер

модели: GTNM-500

Материал: Алюминиево-медный сплав

Индивидуальные: Да

Тип: Другое

Штрих-код: WT06107008

crystal light guide

TEC peltier module

technical board

handpiece shell

metal head

window sapphire

water board

handpiece button

water valve CPC

810 hair removal parts

power supply & screen

LCD & control board

compressor & peltier

fan & water tank

goggles & glasses

OEM pack

ow sensor and

temperature sensor

water pump

water lter

foot pedal

808 diode lasers repair

Aroma

Alma laser repair

Nlight laser stack

Syneron lasers

Dilas laser stack

GT

Focus light lasers

ADELA oroning

Centuryopto OE

other brands

laser handle customize

Syneron handle repair

Aroma handle repair

GSD handle repair

LLD handle repair

ADELA oroning handle

Zema handle repair

Oriental laser handpiece

other brands handle

laser module repair of var

ious brands

Ron laser module

Lee Laser module

FOBA laser module

CEO laser module

DPSS laser module

50w laser diode module

75w laser diode module

100w laser diode module

150w laser diode module

200w laser diode module

300w laser diode module

500w laser diode module

ODM OEM laser module

BrandNew Diode Laser Range:

1) Fiber Coupled Diode Laser

2) Single Emitters Diode Laser

3) Single Bars Diode Laser

4) Vertical Stacked Diode Laser

5) Horizontal Stacked Diode Laser

808nm High Power Diode Laser Hair Removal Handle Piece Demo.

Conductively Cooled Package (CCP) vertical laser diode stacks are mainly designed for low duty solid-state pumping. NDL is working hard to improve the optical power density for these stacks to get max output power within a limited optical window. This kind of laser stack is widely used for Nd:YAG pumping to get high pulse energy in QCW or Pulsed mode.

Features:

QCW laser diode bars with peak power 100W~300W

1~100 bars per stack

Typical 808+/-3nm, other wavelength available

Long life time > 1G Shots

Support custom package design

Model No.	Wavelength	Stacking Method	Diode Bar Type	Diode Bar Numbers	Lead Time	List Price	Add to Cart
-----------	------------	-----------------	----------------	-------------------	-----------	------------	-------------

CVS808A-100x10	805+/-3nm	Vertical Stack	100W QCW	10 Bars	10 workdays	\$2500.00	Add
CVS808B-100x10	810+/-3nm	Vertical Stack	100W QCW	10 Bars	10 workdays	\$2500.00	Add
CHS808-100x2	805+/-3nm	Horizontal Stack	100W QCW	2 Bars	5 workdays	\$500.00	Add
CHS808-100x3	805+/-3nm	Horizontal Stack	100W QCW	3 Bars	5 workdays	\$750.00	Add
CHS808-100x4	805+/-3nm	Horizontal Stack	100W QCW	4 Bars	5 workdays	\$1000.00	Add
CHS808-100x2-2	805+/-3nm	Horizontal Stack	100W QCW	2x2 Bars	10 workdays	\$1000.00	Add
CHS808-100x3-2	805+/-3nm	Horizontal Stack	100W QCW	3x2 Bars	10 workdays	\$1500.00	Add
CHS808-100x4-2	805+/-3nm	Horizontal Stack	100W QCW	4x2 Bars			

Optical Output Power (QCW): 100W, 150W, 200W, 300W per Bar

Diode Bar Numbers 1~100 Bars per Stack

Stacking Method: Vertical Stack, Horizontal Stack, 2D Stack

Wavelength Available: 808nm+/-3nm

Fast Axis Collimation: Optional

Duty Cycle Limited: <2%, < 5%, < 10%

Micro-Channel Cooler Package (MCCP) is designed for high power CW diode bars up to 60W and 80W. The Micro-Channel Cooler (MCC or MC2) is a high efficiency heat-exchange heatsink. These MCCP package can provide up to >1KW CW output power from a single stack for directly heat treatment for industry, such as metal hardening, laser cladding, welding and etc. It is also widely used for hair removal applications.

Features:

Optical power 60W, 80W or 100W CW per bar

1~20 bars per stack

Vertical & horizontal stacks available

Typical 808+/-3nm, other wavelength (940nm, 976nm)available

Long life time > 10,000 hours

Support custom package design

MCCP808-60-1	60W	60W CW	Single Bar	20 workdays	\$420.00	Add
MCCP808H-60-3	180W	60W CW	3-Bar Horizontal Stack	20 workdays	\$1260.00	Add
MCCP808H-60-4	240W	60W CW	4-Bar Horizontal Stack	20 workdays	\$1680.00	Add
MCCP808V-60-8	480W	60W CW	8-Bar Vertical Stack	20 workdays	\$3360.00	Add
MCCP808V-60-12	720W	60W CW	12-Bar Horizontal Stack	20 workdays		

Optical Output Power (CW): 60W, 80W or 100W per Bar

Diode Bar Numbers: 1~20 Bars per Stack

Stacking Method: Vertical or Horizontal Stack

Diode Bar Pitch (Vertical): ~2.0mm

Wavelength Available: 808nm, 940nm, 976nm

Fast Axis Collimation: Optional

Lead Time 15~30 workdays

Model No.	Wavelength	Diode Bar Type	Diode Bar Numbers	Lead Time	List Price	Add to Cart
WLDA808-20x2	805+/-3nm	20W CW 2 Bars	10 workdays		\$360.00	Add
WLDA808-2x3	805+/-3nm	20W CW 3 Bars	5 workdays	\$540.00		Add
WLDA808-20x4	805+/-3nm	20W CW 4 Bars	5 workdays	\$720.00		Add
WLDA808-20x5	805+/-3nm	20W CW 2 Bars	10 workdays		\$900.00	Add
WLDA808-40x2	805+/-3nm	40W CW 2 Bars	10 workdays		\$540.00	Add
WLDA808-40x3	805+/-3nm	40W CW 3 Bars	5 workdays	\$810.00		Add
WLDA808-40x4	805+/-3nm	40W CW 4 Bars	5 workdays	\$1080.00		Add
WLDA808-40x5	805+/-3nm	40W CW 5 Bars	10 workdays		\$1350.00	Add
WLDA808Q-100x2	805+/-3nm	100W QCW 2 Bars	10 workdays		\$500.00	Add
WLDA808Q-100x3	805+/-3nm	100W QCW 3 Bars	5 workdays	\$750.00		Add
WLDA808Q-100x4	805+/-3nm	100W QCW 4 Bars	5 workdays	\$1000.00		Add
WLDA808Q-100x5	805+/-3nm	100W QCW 5 Bars	10 workdays		\$1250.00	Add
WLDA808Q-100x2-2	805+/-3nm	100W QCW 2x2 Bars	10 workdays		\$1000.00	Add
WLDA808Q-100x3-2	805+/-3nm	100W QCW 3x2 Bars	10 workdays		\$1500.00	Add
WLDA808Q-100x4-2	805+/-3nm	100W QCW 4x2 Bars	10 workdays		\$2000.00	Add
WLDA808Q-100x5-2	805+/-3nm	100W QCW 5x2 Bars	10 workdays		\$2500.00	Ad

Optical Output Power (CW): 20W, 40W per bar

Optical Output Power (QCW): 100W, 150W, 200W, 300W per Bar

Diode Bar Numbers 1~20 Bars per Stack

Wavelength Available: 805nm+/-3nm

Heatsink Standard or custom heatsink upon request

Model No.	Wavelength	Fiber Type	Lead Time	List Price	Add to Cart
-----------	------------	------------	-----------	------------	-------------

FCD01-808	805+/-3nm	105/125um NA=0.22	5 workdays	\$200.00	Add
-----------	-----------	-------------------	------------	----------	-----

FCD01-980 976+/-3nm105/125um NA=0.22	In stock	\$200.00	Add
FCD02-795 795+/-3nm105/125um NA=0.22	In stock	\$290.00	Add
FCD02-808 805+/-3nm105/125um NA=0.22	In stock	\$290.00	Add
FCD03-808 805+/-3nm105/125um NA=0.22	In stock	\$380.00	Add
FCD03-940 805+/-3nm105/125um NA=0.22	In stock	\$380.00	Add
FCD03-976 976+/-3nm105/125um NA=0.22	In stock	\$380.00	Add
FCD06-808 805+/-3nm200/240um NA=0.22	20 workdays	\$560.00	Add
FCD09-976 976+/-10nm	105/125um NA=0.22	In stock	\$650.00 Add
FCD25-940 940+/-10nm	105/125um NA=0.15	In stock	\$1250.00 Add
FCD25-976 976+/-10nm	105/125um NA=0.15	20 workdays	\$1250.00 Add

NDL provides various cooling devices and temperature controllers for lasers, including:

Features:

Peltier (TEC, TE Cooler) Temperature Controller for lasers

Forced Air Cooling Stage for lasers.

Water Cooling Stage for lasers

Laser Water Chiller

Support high operation temperature up to 380°C

SMA-905, ST, FC/PC connectors for patch cords

Collimation or focus head available

Industry Area Typical Applications Typical Laser Solutions

- | | |
|-------------------------------------|------------------------------|
| 1. Medical & Surgery Lasers | 1. ELVT |
| 2. General Surgery | |
| 3. Dental Lasers | 1. Fiber Coupled Diode Laser |
| 2. Fiber Coupled CW DPSS Laser | |
| 2. Aesthetic Treatment Lasers | 1. Diode Laser Hair Removal |
| 2. Tattoo Removal | 1. 808nm Stacked Diode Laser |
| 2. Q-switched YAG Laser & SHG Laser | |

Large spot 600w 808nm handpiece permanent diode laser hair removaltack

Large spot 600w 808nm handpiece permanent diode laser hair removaltack

Description:Wavelength: 808nmLaser power: 600WLaser bar: Germany Jenoptik barLaser stack: Micro chan..

Диодный лазер In-Motion D1,Диодный лазер In-Motion ,Диодный лазер KIERS KES-144 ,Диодный лазер ViaSta
 ДИОДНЫЙ ЛАЗЕР KIERS-144,ДИОДНЫЙ ЛАЗЕР TOPLASER,ДИОДНЫЙ ЛАЗЕР KIERS 145,ДИОДНЫЙ ЛАЗЕР ANCHORFREE,ДИОДНЫЙ ЛАЗЕР
 EVESIDEДИОДНЫЙ ЛАЗЕР SHR MEDUSA,ДИОДНЫЙ ЛАЗЕР KASTOR,Диодный лазер SHR BL1Диодный лазер ADSS FG-2000B,

ДИОДНЫЙ ЛАЗЕР SHR BL-1,Диодный лазер 755/808/1064 BM-108,Диодный лазер 808 nm MY-318,Диодный лазерный аппарат для эпиляции «Beauty Instrument Super Power» (808 nm),
Диодный лазер для эпиляции 808 nm + Nd Yag Laser 532/1320/1064 DPL 1,Диодный лазер для эпиляции 808/ 755/ 1064 nm + Nd Yag Laser 532/1320/1064 DPL 1,,Диодный лазер DPL 4 В 1:808+ELOS+nd yag laser+RF,
Горячая 808 диодный лазер волос Removal 20 миллионов снимков 810nm / 808nm диодный лазер для удаления волос
DS-74, 808nm diode laser DS-88,DS-86,DS-65,DS-43,DS-88, DS-65,DS-74,D-65456,DS-35,Oriental-laserТип товара: Наборы ToiletryShell applied 1: diode laser hair removal machine 808nmShell applied 2: diode laser beauty machineShell applied 3: 1060nm laser slimming machine, A0508,FR-808O3,OFAN,FR-NS840,FR-808O2,500W 808,500W 755 808 1064,300W 808 ,Название бренда: miruouu,DLS808 ,miruouu,Название бренда: adg, CF-1,
CL-1, DPL-4C, DPL-4B, ALD-1, LD-6, APQ-1S, DPL-4A, APDL-2B, ADL-5, LD-5, LD-2, ALD-2,диодных лазеров с вакуумным усилением и аппаратов для эпиляции: Kiers 144, Kiers 145, D-las, FG-2000B, DPSS, SHR BL1, Wingderm, SL 600, SL 500, DL-07, FG2000D, SDL-C, Ruikd, LD4, Silvano, Esteban+Модели неодимовых лазеров:ЛАЗЕР RY 580,ЛАЗЕР SCINONE ULTRA II,ЛАЗЕР E-DOCTOR,ЛАЗЕР MED 810A,ЛАЗЕР MASK TATOO,YL-V10-L - Nd:YAG неодимовый лазер для удаления татуировок,Лазер удаления тату и татуажа MagiCosmo K690, ЛАЗЕР LASERLIGHT,ЛАЗЕР HANTER,Неодимовый лазер для удаления тату Yinhe-V2,Неодимовый лазер для удаления тату Yinhe-V18,Неодимовый лазер сверхкороткого импульса Pico-Light Brilliant, Неодимовый лазер для удаления тату AL1 Nd:Yag с технологией Q-Switch (Syndrome Tattoo),Неодимовый лазер для удаления тату Yinhe-Butterfly,Лазер для удаления татуировок Nano-Light 12, Компактный Nd:YAG компактный неодимовый лазер YL-V35 для удаления татуировок и карбонового пилинга,Nd:YAG - Неодимовый лазер для карбонового пилинга и удаления татуировок YL-V20-A,Многофункциональный аппарат MAGNETO 360,Неодимовый лазер RL-A01, Неодимовый лазер для удаления тату YAG FQ015-1 с указкой,YL-V10-C - Nd:YAG неодимовый лазер для удаления татуировок,Неодимовый лазер для удаления тату TL-500, Nd:YAG неодимовый лазер для удаления татуировок и карбонового пилинга YL-V20,YL-V10 - Nd:YAG неодимовый лазер для удаления татуировок,Nd:YAG неодимовый лазер для удаления татуировок YL-V14, Nd:YAG неодимовый лазер для удаления татуировок и карбонового пилинга YL-V22,Компактный неодимовый лазер FQ019 для работы на выезде,Лазер неодимовый для удаления тату Fq018,овок YL-V12,Многофункциональный аппарат RL-a03, Неодимовый лазер для удаления тату AL1 Nd:Yag с технологией Q-Switch (Syndrome Tattoo),ScinOne X,Неодимовый лазер ScinOne Ultra II,KES MED-810A, Неодимовый лазер для удаления тату Yinhe-Butterfly с указкой,Happy-light SE,Лазер для удаления татуировок Nano Light 10,Стационарный неодимовый лазер для карбонового пилинга и удаления тату FQ013,Неодимовый лазер VRS11

Ремонт неодимовых лазеров (Nd:YAG)

Ремонт диодных лазеров 808nm для эпиляции

Ремонт манипул для лазерной эпиляции

Ремонт манипул для удаления татуировок

Замена ламп в манипулах Nd:YAG

Замена диодных модулей в манипулах диодных лазеров

Лампы для неодимовых лазеров Nd:YAG

Манипулы для неодимовых лазеров

Фильтры-насадки для неодимовых лазеров

Манипулы для диодных лазеров

также поставляем новые манипулы по привлекательным ценам

дисплеи аппаратов;

пульта управления оборудованием;

лампы;

манипулы;

насадки;

лазеры;

гофры;

компрессоры и многое другое